



**Internationales Fahrturnier
International Driving Event
CAI 3*/CAI 2*
Nationales Fahrturnier
CAN**

11.04.-14.04.2024

**Liebe Teilnehmer/innen,
Herzlich Willkommen zum diesjährigen Fahrturnier
beim
„Fahr - und Reitverein Wettringen“.
Getreu unserem Motto
„Turnier von Fahrern für Fahrer“
wünschen wir Euch viel Erfolg und vor Allem viel
Spaß!**

**Dear participants,
Welcome to this year's driving competition at
„Fahr - und Reitverein Wettringen“.
True to our motto
"Tournament by drivers for drivers"
we wish you success and above all a lot of fun!**

Teilnehmerunterlagen Competitorsmap





**Internationales Fahrturnier
International Driving Event CAI 3*/CAI 2*
Nationales Fahrturnier CAN**

11.04.-14.04.2024

**Section A for all
classes**

**Aufwärmstrecke für
alle Klassen**

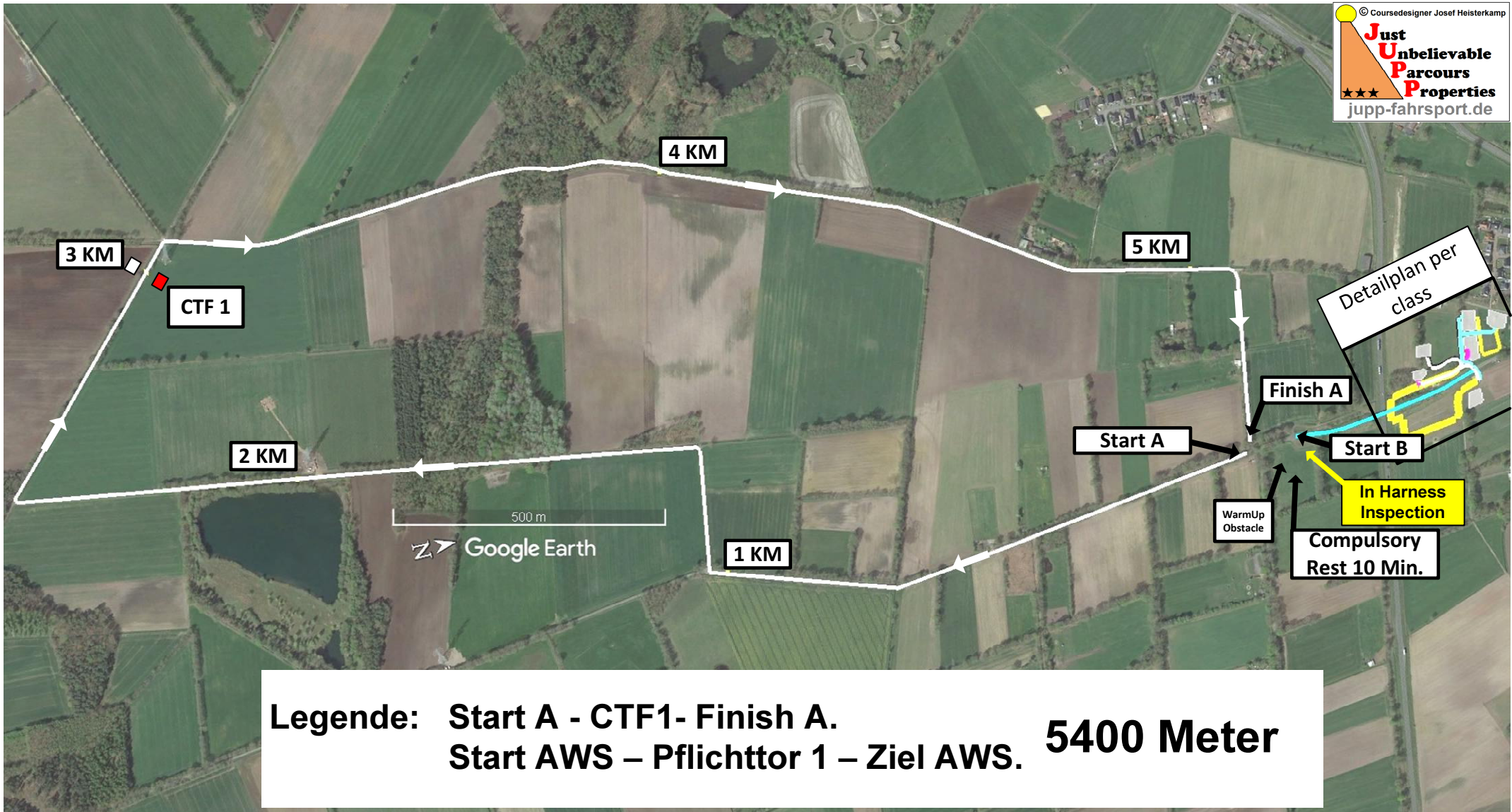



Internationales Fahrturnier
 International Driving Event CAI 3*/CAI 2*
 Nationales Fahrturnier CAN

11.04.-14.04.2024

Section B 3*
5290 Meter

© Course designer Josef Heisterkamp
Just Unbelievable Parcours Properties
 ★★★
 jupp-fahrsport.de

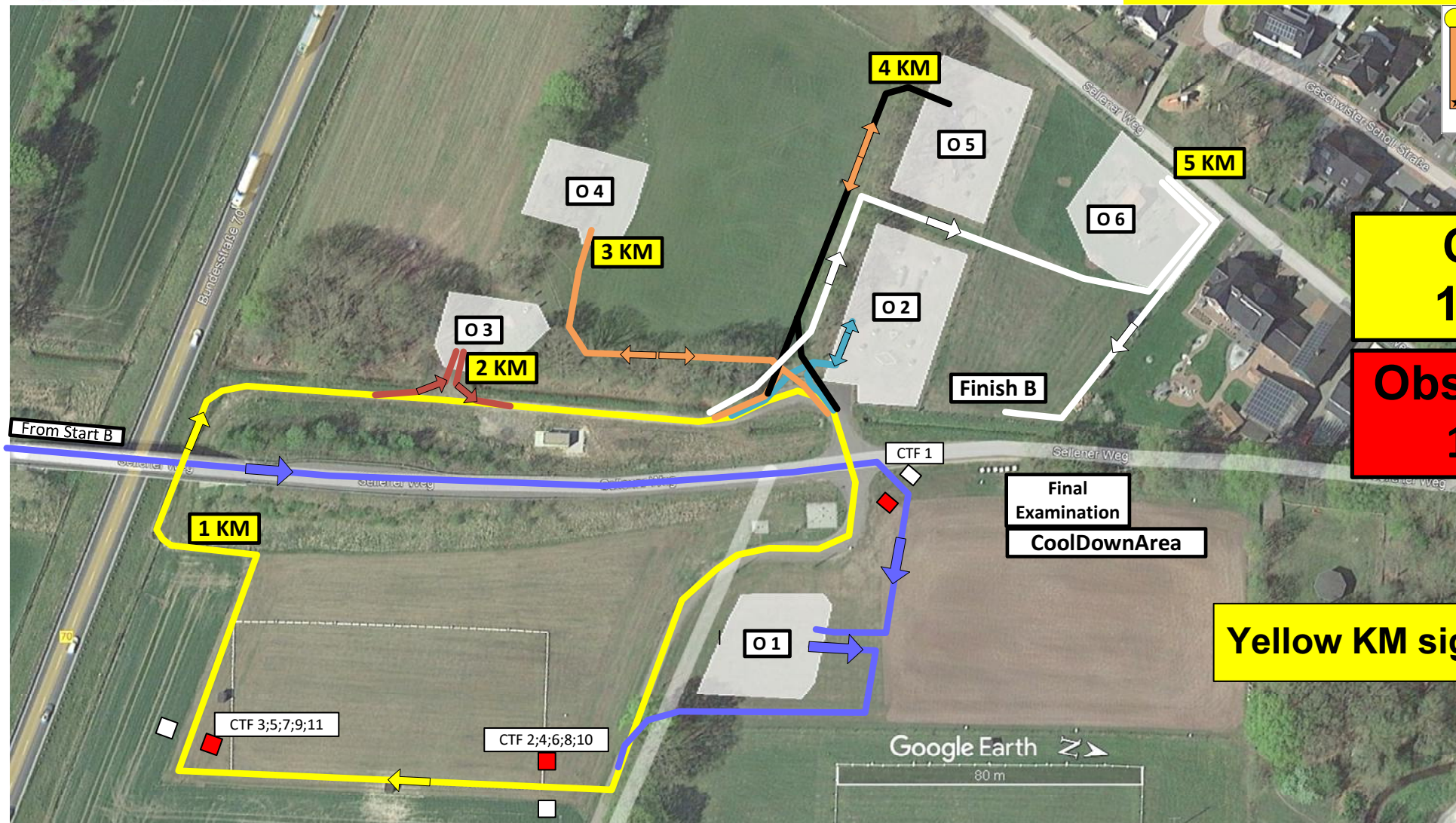

CTF
1 - 11

Obstacles
1 - 6

Yellow KM signs for 3*

Legende: Start B / CTF1 / **O1** / CTF2 / CTF3 / **1 KM** / **O2** / CTF4 / CTF5 / **O3** / **2 KM** / CTF6 / CTF7 / **O4** / **3 KM** / CTF8 / CTF9 / **O5** / **4 KM** / CTF10 / CTF11 / **O6** / **5 KM** / Finish B. 5290 Meter



Times Marathon Geländezeiten

CAI 3* H1/H2 HORSES Comp. Nr.: 10;14	Length in Meter	Tempo KM/h	Minimum Time h:min:sec	Time allowed h:min:sec	Maximum Time h:min:sec	Compulsory Turning Flags	Obstacles
Section A	5400	13	00:22:55	00:24:55	00:29:54	CTF 1	
REST				00:10:00			
Section B	5290	14	00:19:40	00:22:40	00:45:21	CTF 1-11	1 to 6
Cool Down	Area		00:10:00		00:15:00		

CAI 2* H1 HORSES Comp. Nr.: 6	Länge in Meter	Tempo KM/h	Minimum Time h:min:sec	Time allowed h:min:sec	Maximum Time h:min:sec	Compulsory Turning Flags/ Pflichttore	Obstacles
Section A	5400	12	00:25:00	00:27:00	00:32:24	CTF 1	
REST				00:10:00			
Section B	5000	13	00:20:05	00:23:05	00:46:09	CTF 2-11	2 to 6
Cool Down	Area		00:10:00		00:15:00		

CAI 2* P1 PONYS Comp. Nr.: 2	Länge in Meter	Tempo KM/h	Minimum Time h:min:sec	Time allowed h:min:sec	Maximum Time h:min:sec	Compulsory Turning Flags/ Pflichttore	Obstacles
Section A	5400	11	00:27:27	00:29:27	00:35:21	CTF 1	
REST				00:10:00			
Section B	5000	12	00:22:00	00:25:00	00:50:00	CTF 2-11	2 to 6
Cool Down	Area		00:10:00		00:15:00		

Klasse A national PFERDE Prg. Nr.: 23;31	Länge in Meter	Tempo KM/h	Minimum Time h:min:sec	Time allowed h:min:sec	Maximum Time h:min:sec	Compulsory Turning Flags/ Pflichttore	Obstacles/ Hindernisse
Aufwärmstrecke	5400	11,5	00:26:10	00:28:10	00:33:49	CTF 1	
Zwangspause				00:10:00			
Hindernisstrecke	3845	12,5	00:15:27	00:18:27	00:36:55	CTF 2-9	2;3;5;6

Klasse A national PONYS Prg. Nr.: 19;27	Länge in Meter	Tempo KM/h	Minimum Time h:min:sec	Time allowed h:min:sec	Maximum Time h:min:sec	Compulsory Turning Flags/ Pflichttore	Obstacles/ Hindernisse
Aufwärmstrecke	5400	11	00:27:27	00:29:27	00:35:21	CTF 1	
Zwangspause				00:10:00			
Hindernisstrecke	3845	12	00:16:14	00:19:14	00:38:27	CTF 2-9	2;3;5;6



Internationales Fahrturnier
International Driving Event
CAI 3*/CAI 2*
Nationales Fahrturnier
CAN
11.04.-14.04.2024

Hindernis **1**
Obstacle

CAI 3* only!

Powered by:

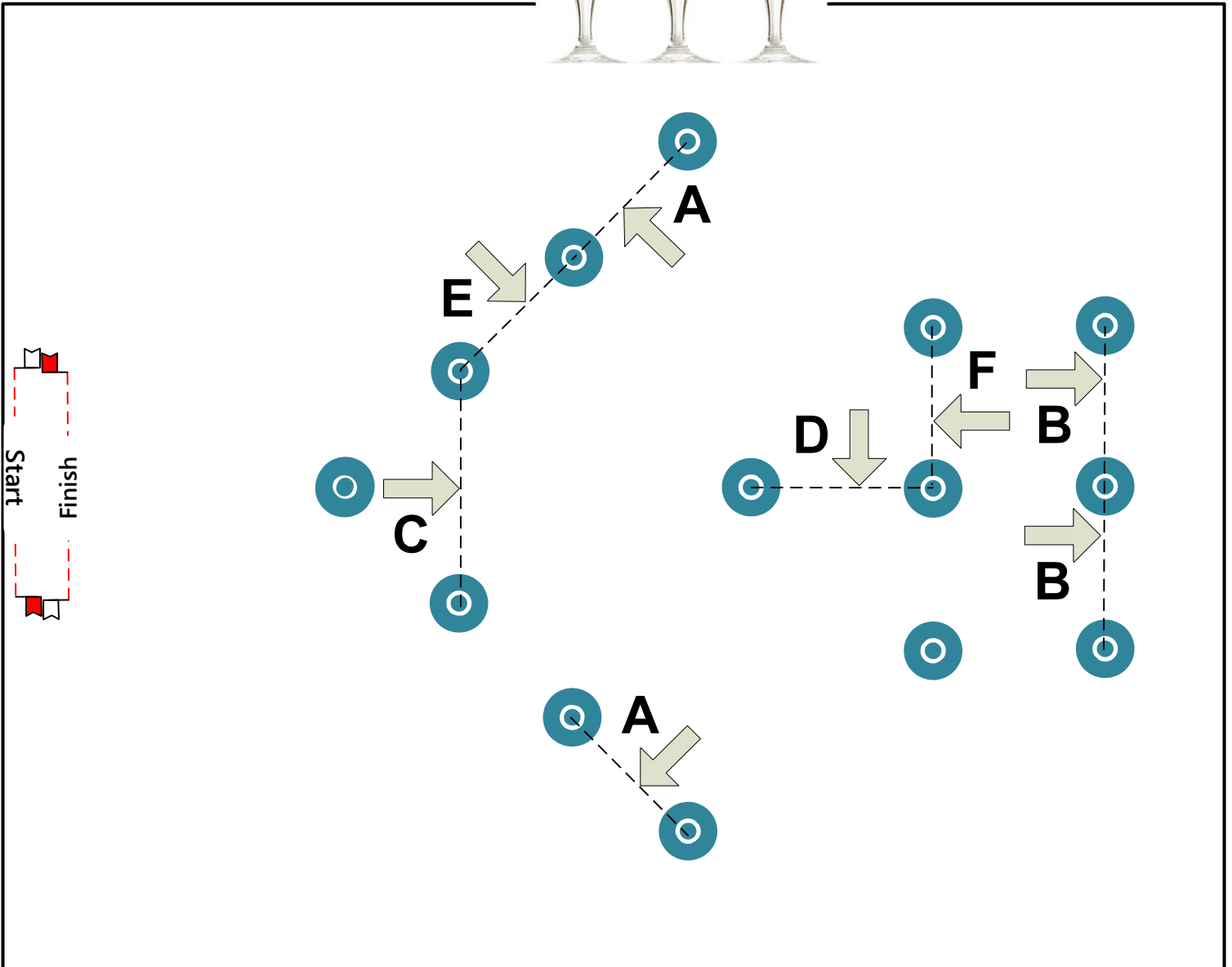



Internationales Fahrturnier
International Driving Event
CAI 3*/CAI 2*
Nationales Fahrturnier
CAN
11.04.-14.04.2024

Hindernis
Obstacle **2**

Powered by:



Geländefahren Kl. A
Prfg.Nr: 19;23;27 und 31 nur
Tore A-D

Wall

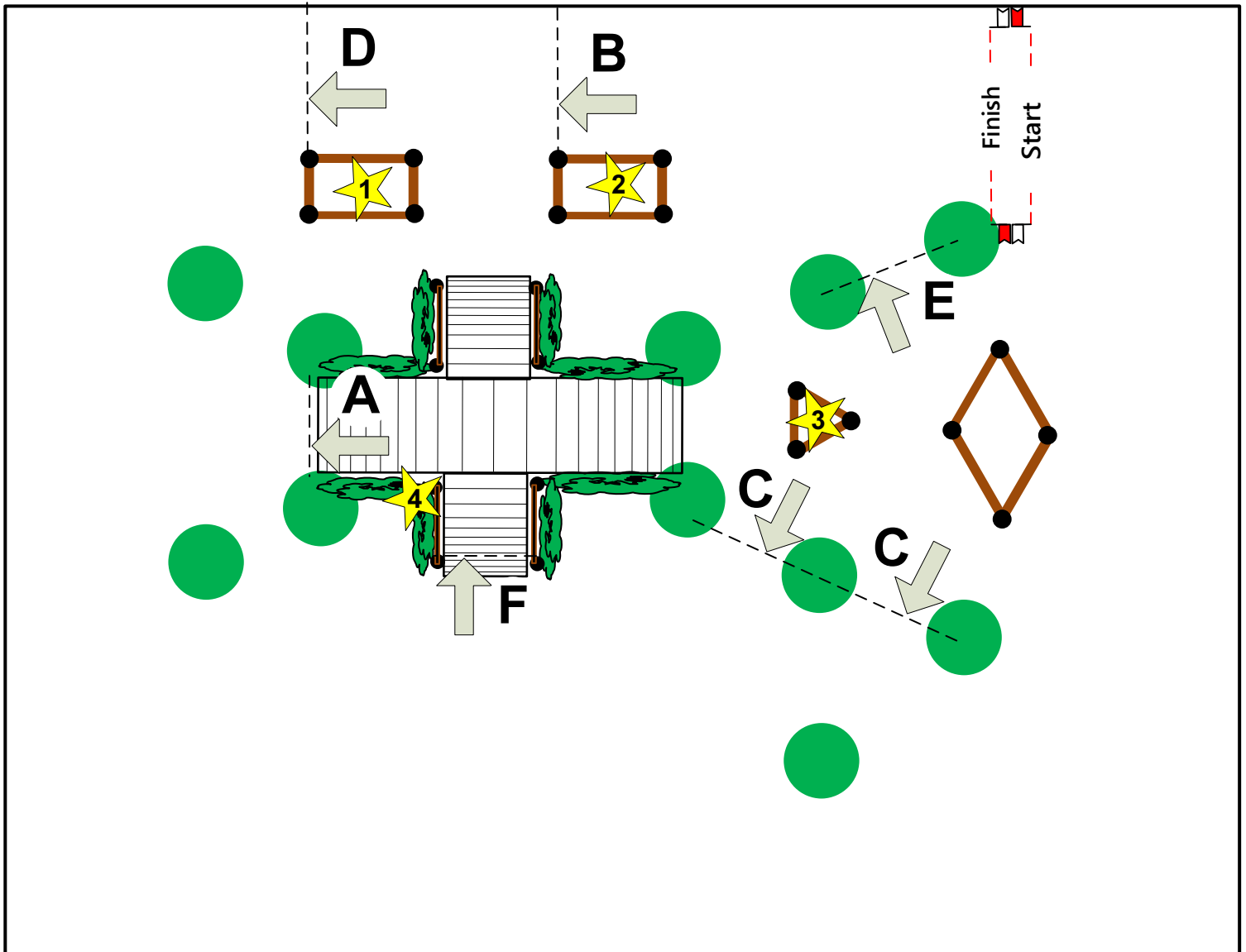

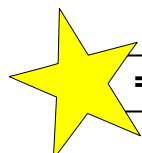
 = 4 Knock Down



Internationales Fahrturnier
International Driving Event
CAI 3*/CAI 2*
Nationales Fahrturnier
CAN
11.04.-14.04.2024

Hindernis
Obstacle **3**

Powered by:



Menzel's
Wassergraben

Geländefahren Kl. A

Prfg.Nr: 19;23;27 und 31 nur

Tore A-D

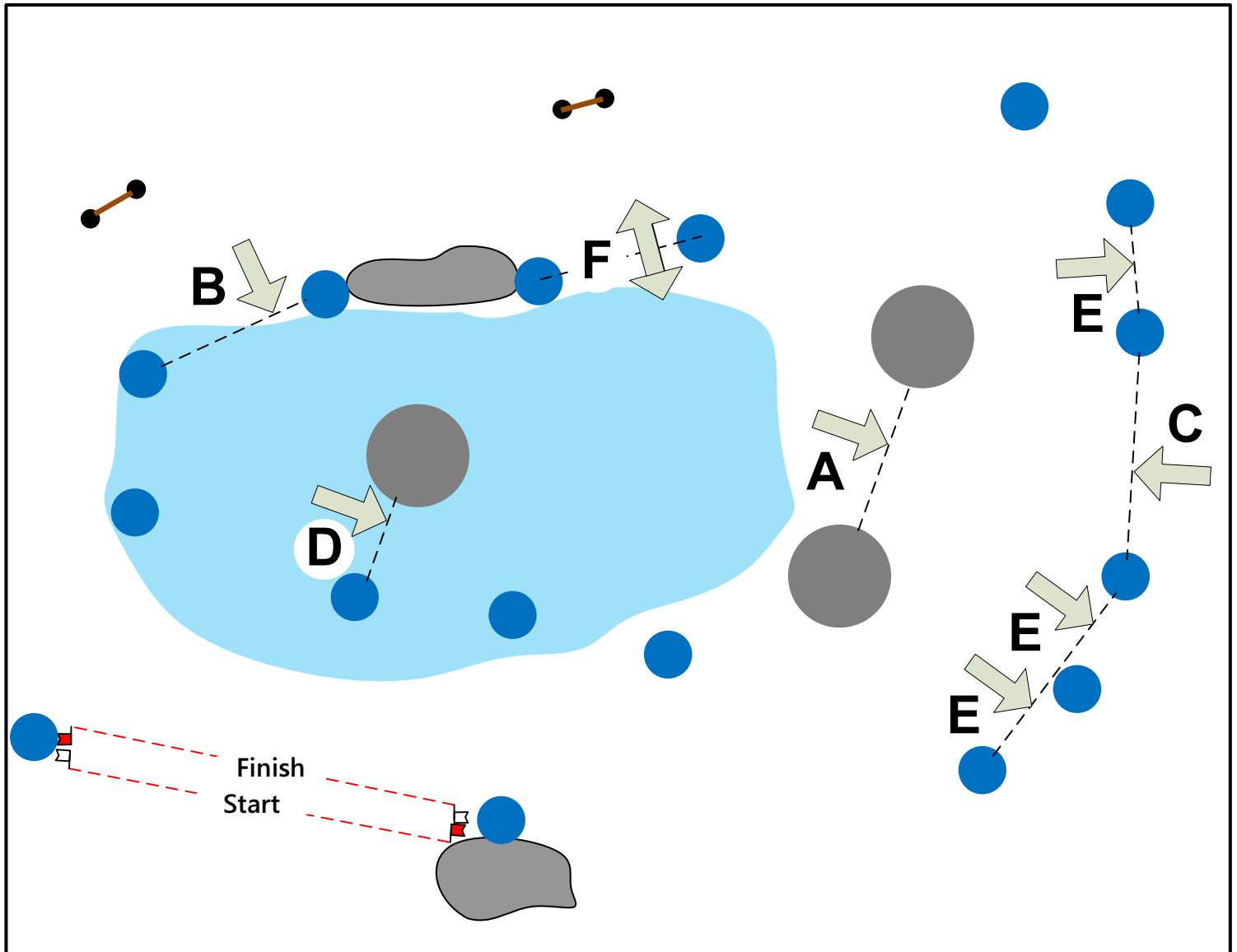



Internationales Fahrturnier
International Driving Event
CAI 3*/CAI 2*
Nationales Fahrturnier
CAN
11.04.-14.04.2024

Hindernis
Obstacle
4

Powered by:



Märchenwald

CAI 3* Gate A-F

CAI 2* only Gate A-E

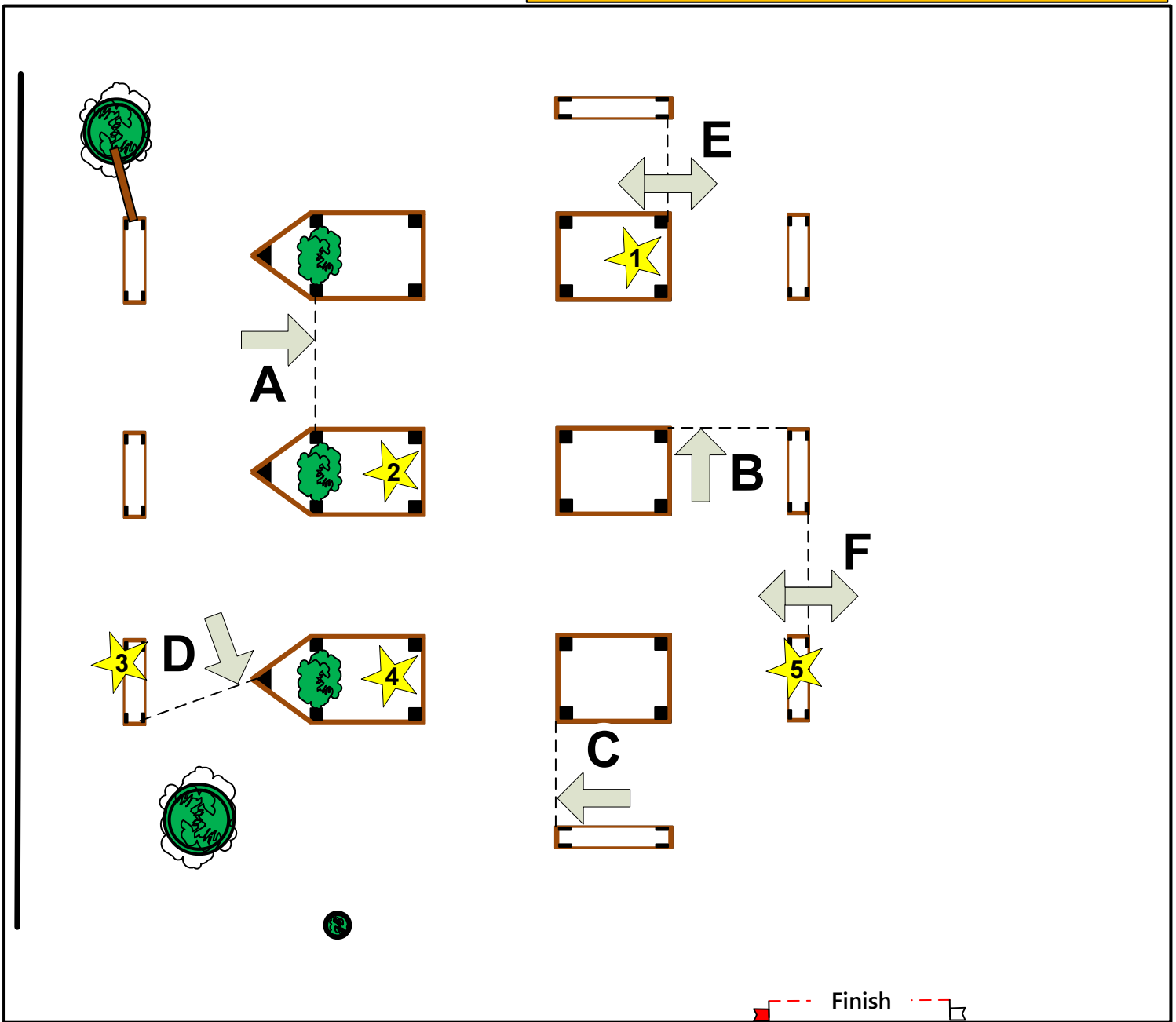

= 5 Knock Down

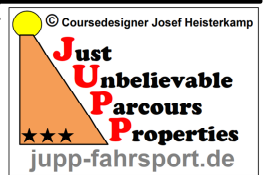



Internationales Fahrturnier
International Driving Event
CAI 3*/CAI 2*
Nationales Fahrturnier
CAN
11.04.-14.04.2024

Hindernis
Obstacle **5**

Powered by:



Elektro Brinner Brücke

Geländefahren Kl. A

Prfg.Nr: 19;23;27 und 31 nur

Tore A-D

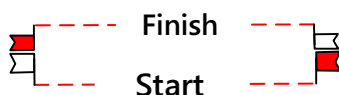
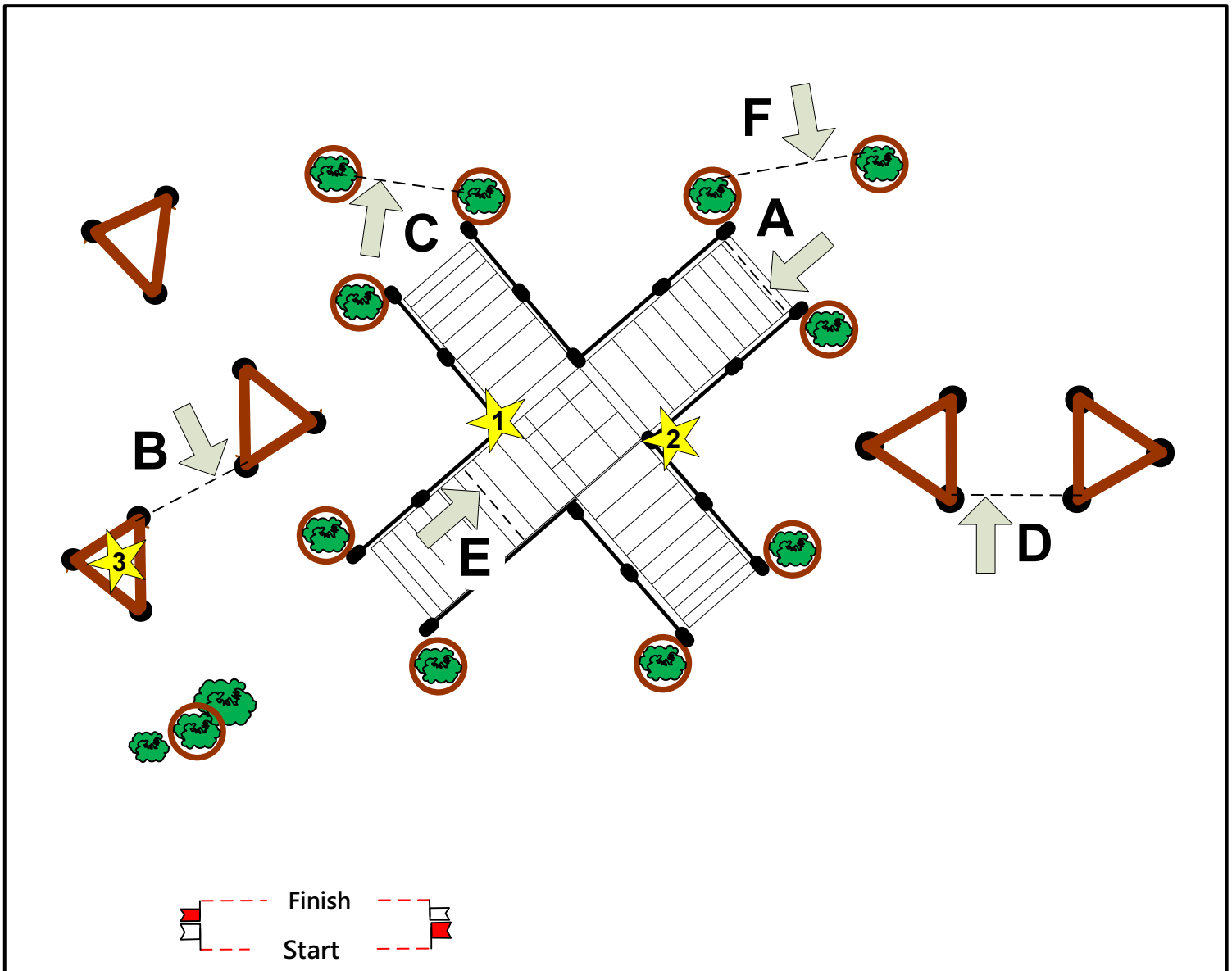

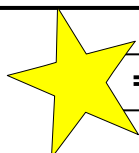
 = 3 Knock Down



Internationales Fahrturnier
International Driving Event
CAI 3*/CAI 2*
Nationales Fahrturnier
CAN
11.04.-14.04.2024

Hindernis
Obstacle **6**

Powered by:



Hüsches
PS Schuppen

Geländefahren Kl. A
Prfg.Nr: 19;23;27 und 31 nur

Tore A-D

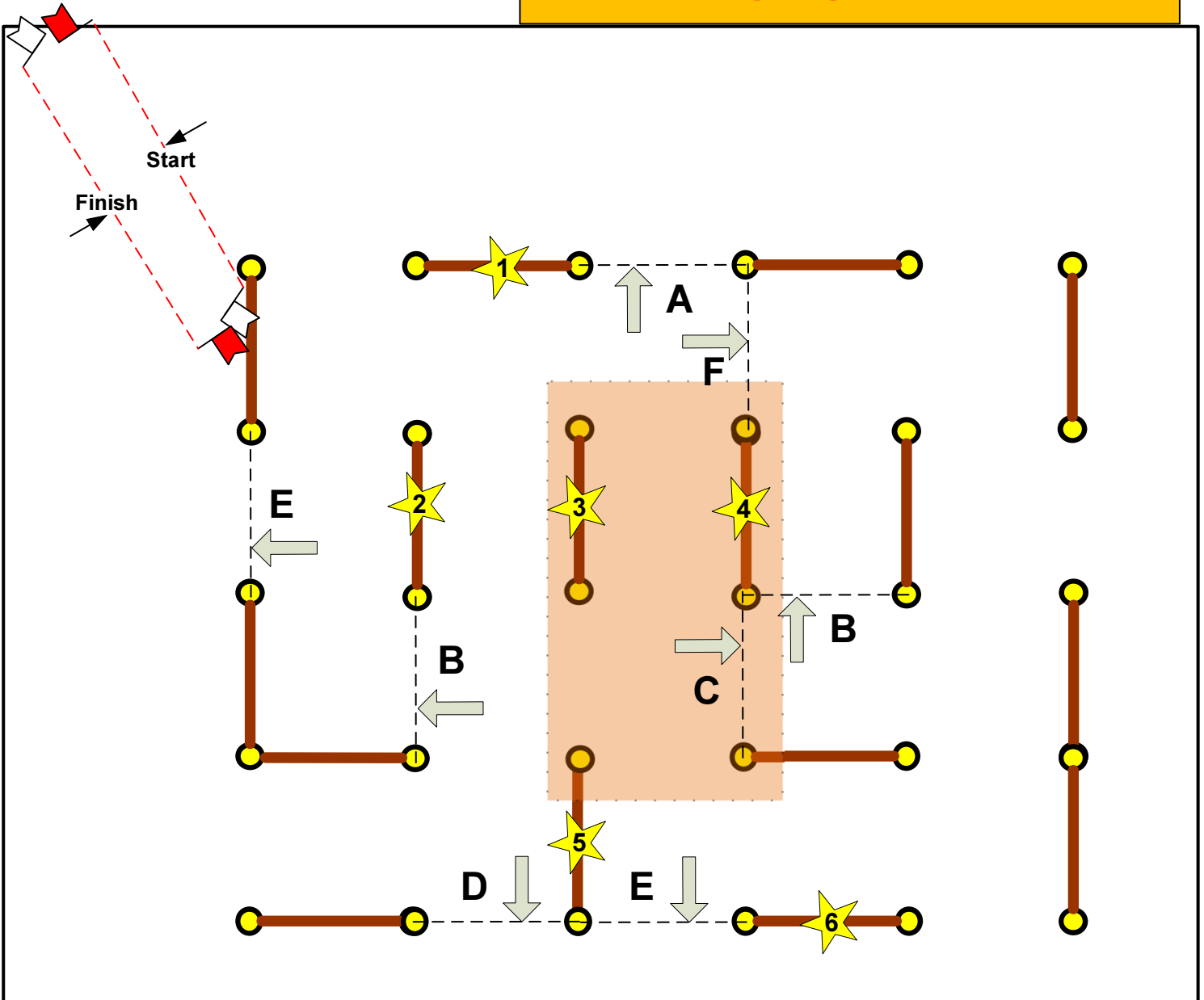

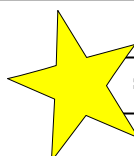
 = 6 Knock Down



**Internationales Fahrturnier
International Driving Event
CAI 3*/CAI 2*
Nationales Fahrturnier
CAN**

11.04.-14.04.2024

**Liebe Teilnehmer/innen,
Herzlich Willkommen zum diesjährigen Fahrturnier
beim
„Fahr - und Reitverein Wettringen“.
Getreu unserem Motto
„Turnier von Fahrern für Fahrer“
wünschen wir Euch viel Erfolg und vor Allem viel
Spaß!**

**Dear participants,
Welcome to this year's driving competition at
„Fahr - und Reitverein Wettringen“.
True to our motto
"Tournament by drivers for drivers"
we wish you success and above all a lot of fun!**

Teilnehmerunterlagen Competitorsmap

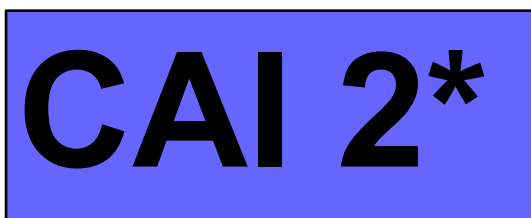



**Internationales Fahrturnier
International Driving Event CAI 3*/CAI 2*
Nationales Fahrturnier CAN**

11.04.-14.04.2024

**Section A for all
classes**

**Aufwärmstrecke für
alle Klassen**

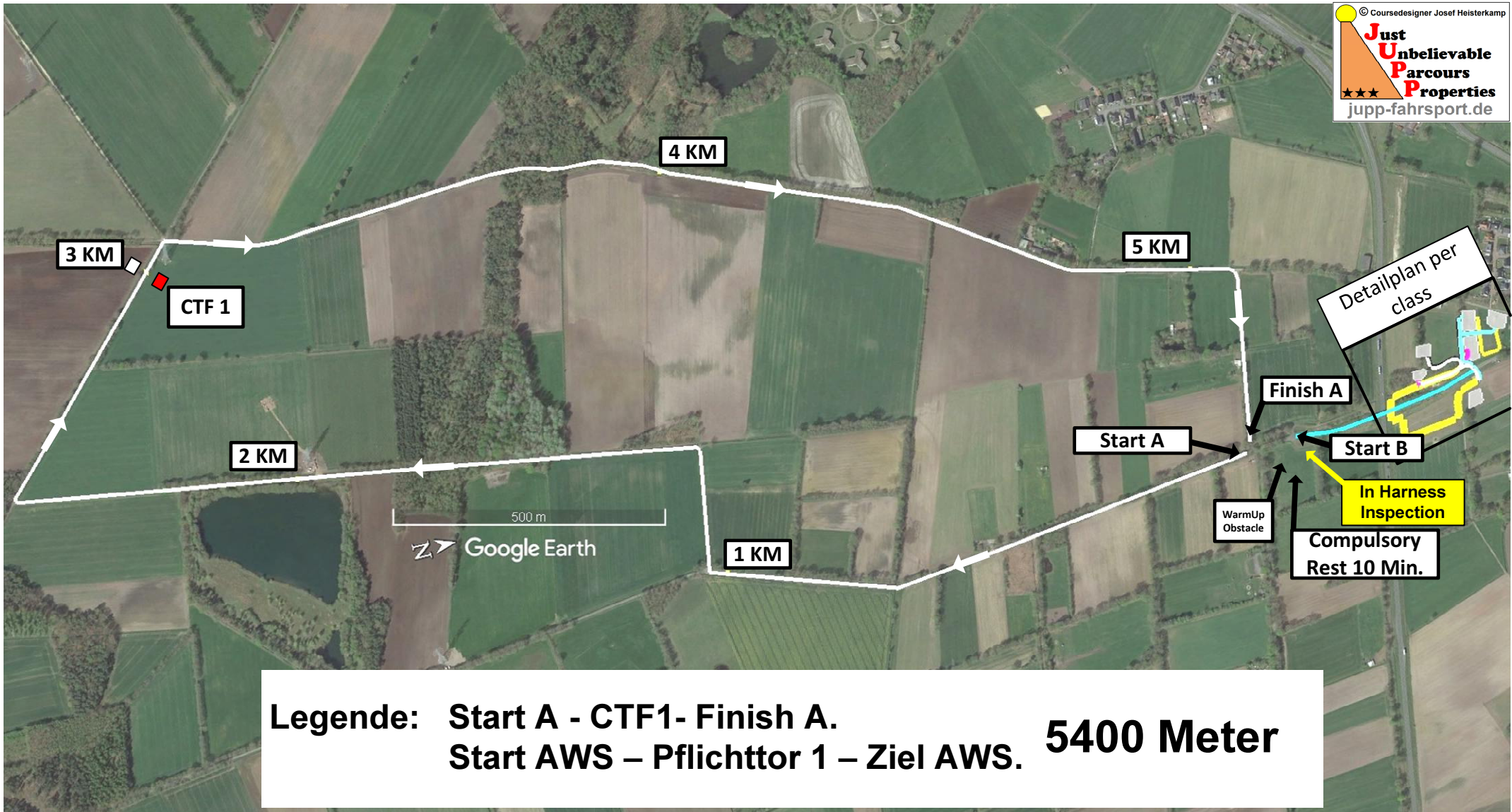



Internationales Fahrturnier International Driving Event CAI 3*/CAI 2* Nationales Fahrturnier CAN

11.04.-14.04.2024

Section B 2* 5000 Meter

© Courseedesigner Josef Heisterkamp
Just Unbelievable Parcours Properties
★★★★ jupp-fahrsport.de

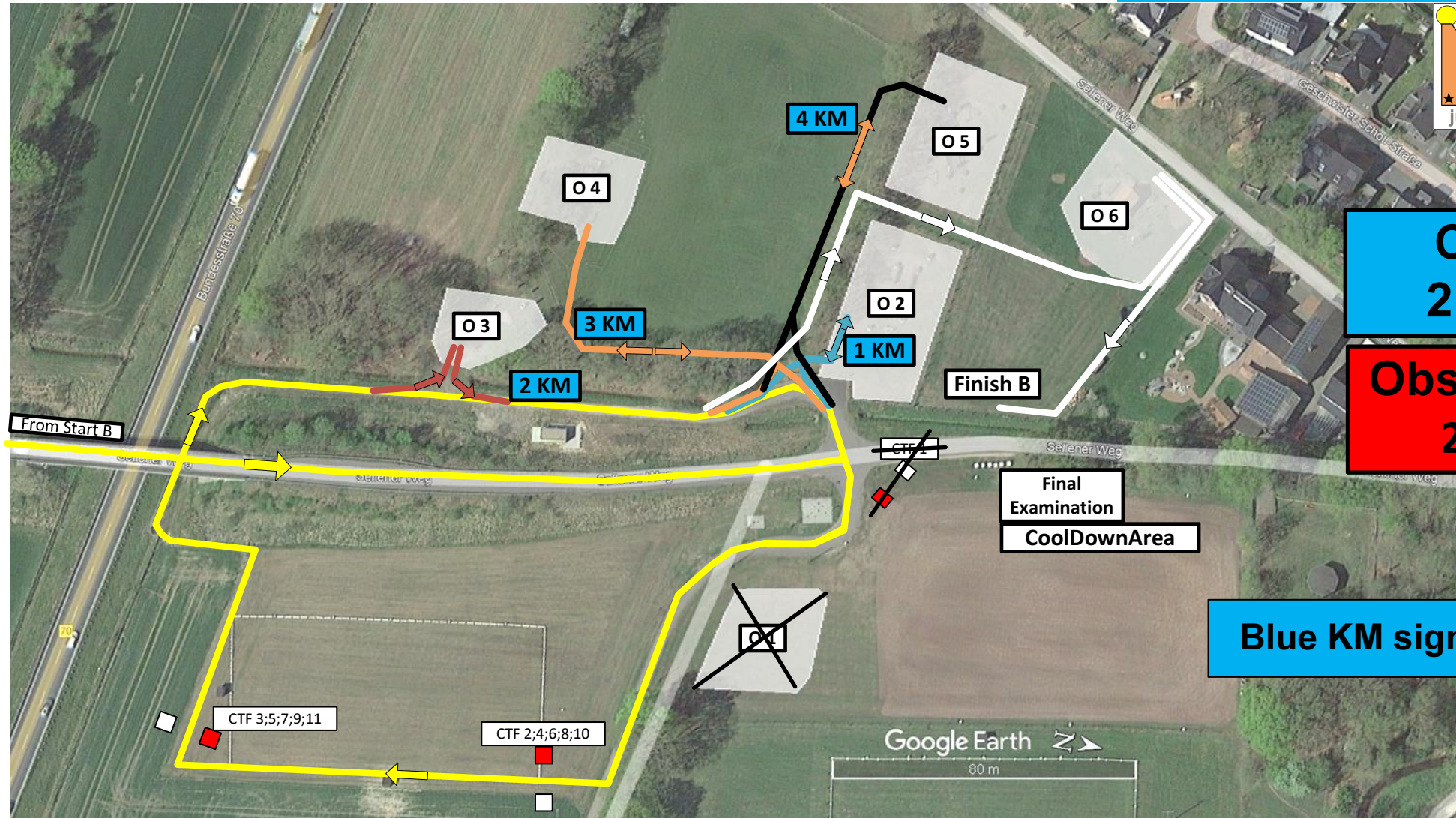

**CTF
2 - 11**

**Obstacles
2 - 6**

Blue KM signs for 2*

Legende: Start B / CTF2 / CTF3 / **O2** / **1 KM** / CTF4 / CTF5 / **O3** / **2 KM** / CTF6 / CTF7 / **O4** / **3 KM** / CTF8 / CTF9 / **O5** / **4 KM** / CTF10 / CTF11 / **O6** / Finish B. 5000 Meter



Times Marathon Geländezeiten

CAI 3* H1/H2 HORSES Comp. Nr.: 10;14	Length in Meter	Tempo KM/h	Minimum Time h:min:sec	Time allowed h:min:sec	Maximum Time h:min:sec	Compulsory Turning Flags	Obstacles
Section A	5400	13	00:22:55	00:24:55	00:29:54	CTF 1	
REST				00:10:00			
Section B	5290	14	00:19:40	00:22:40	00:45:21	CTF 1-11	1 to 6
Cool Down	Area		00:10:00		00:15:00		

CAI 2* H1 HORSES Comp. Nr.: 6	Länge in Meter	Tempo KM/h	Minimum Time h:min:sec	Time allowed h:min:sec	Maximum Time h:min:sec	Compulsory Turning Flags/ Pflichttore	Obstacles
Section A	5400	12	00:25:00	00:27:00	00:32:24	CTF 1	
REST				00:10:00			
Section B	5000	13	00:20:05	00:23:05	00:46:09	CTF 2-11	2 to 6
Cool Down	Area		00:10:00		00:15:00		

CAI 2* P1 PONYS Comp. Nr.: 2	Länge in Meter	Tempo KM/h	Minimum Time h:min:sec	Time allowed h:min:sec	Maximum Time h:min:sec	Compulsory Turning Flags/ Pflichttore	Obstacles
Section A	5400	11	00:27:27	00:29:27	00:35:21	CTF 1	
REST				00:10:00			
Section B	5000	12	00:22:00	00:25:00	00:50:00	CTF 2-11	2 to 6
Cool Down	Area		00:10:00		00:15:00		

Klasse A national PFERDE Prg. Nr.: 23;31	Länge in Meter	Tempo KM/h	Minimum Time h:min:sec	Time allowed h:min:sec	Maximum Time h:min:sec	Compulsory Turning Flags/ Pflichttore	Obstacles/ Hindernisse
Aufwärmstrecke	5400	11,5	00:26:10	00:28:10	00:33:49	CTF 1	
Zwangspause				00:10:00			
Hindernisstrecke	3845	12,5	00:15:27	00:18:27	00:36:55	CTF 2-9	2;3;5;6

Klasse A national PONYS Prg. Nr.: 19;27	Länge in Meter	Tempo KM/h	Minimum Time h:min:sec	Time allowed h:min:sec	Maximum Time h:min:sec	Compulsory Turning Flags/ Pflichttore	Obstacles/ Hindernisse
Aufwärmstrecke	5400	11	00:27:27	00:29:27	00:35:21	CTF 1	
Zwangspause				00:10:00			
Hindernisstrecke	3845	12	00:16:14	00:19:14	00:38:27	CTF 2-9	2;3;5;6



Internationales Fahrturnier
International Driving Event
CAI 3*/CAI 2*
Nationales Fahrturnier
CAN
11.04.-14.04.2024

Hindernis
Obstacle **2**

Powered by:



Geländefahren Kl. A
Prfg.Nr: 19;23;27 und 31 nur
Tore A-D

Wall

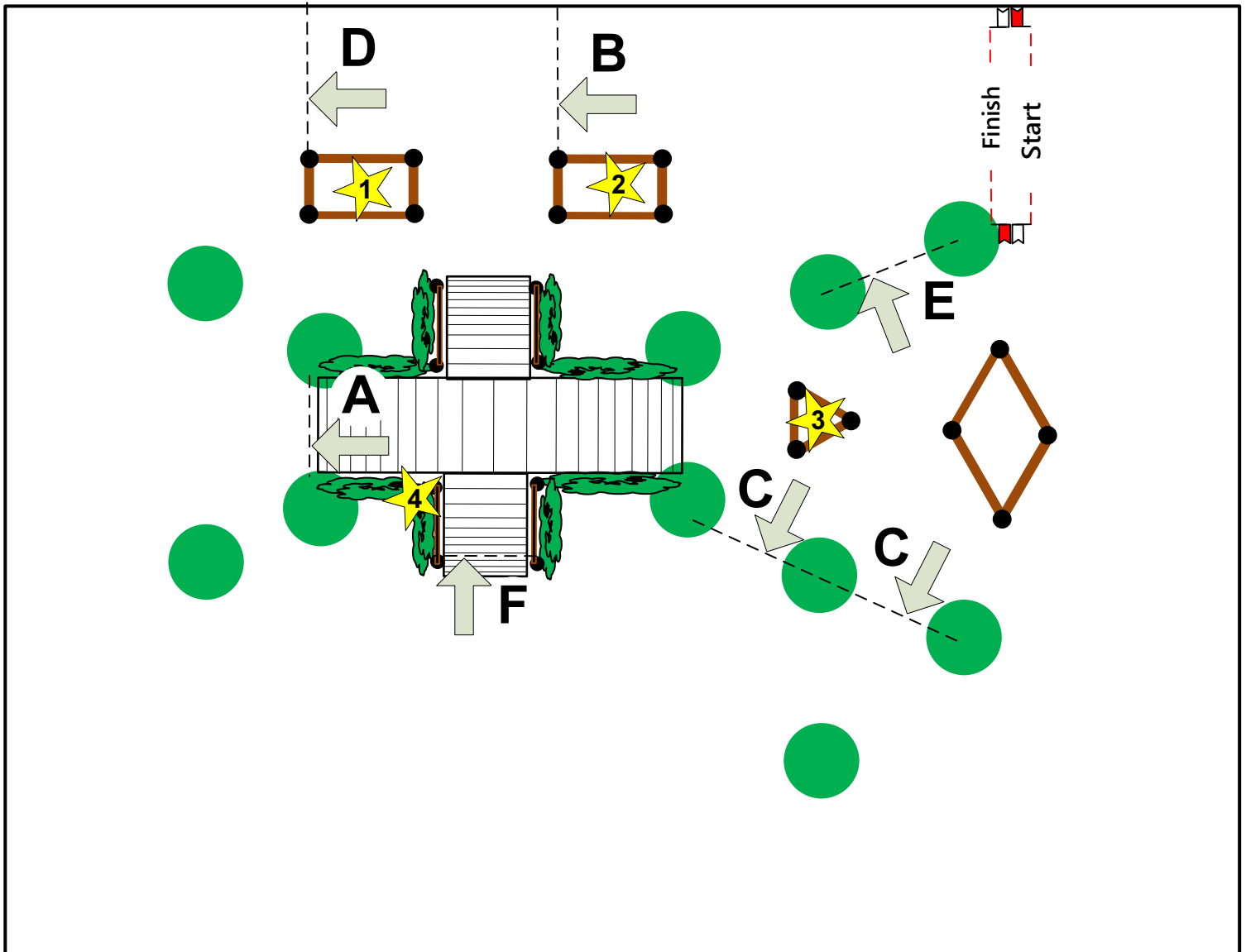

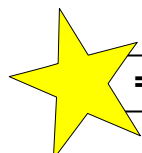
 = 4 Knock Down



Internationales Fahrturnier
International Driving Event
CAI 3*/CAI 2*
Nationales Fahrturnier
CAN
11.04.-14.04.2024

Hindernis
Obstacle **3**

Powered by:



Menzel's
Wassergraben

Geländefahren Kl. A

Prfg.Nr: 19;23;27 und 31 nur

Tore A-D

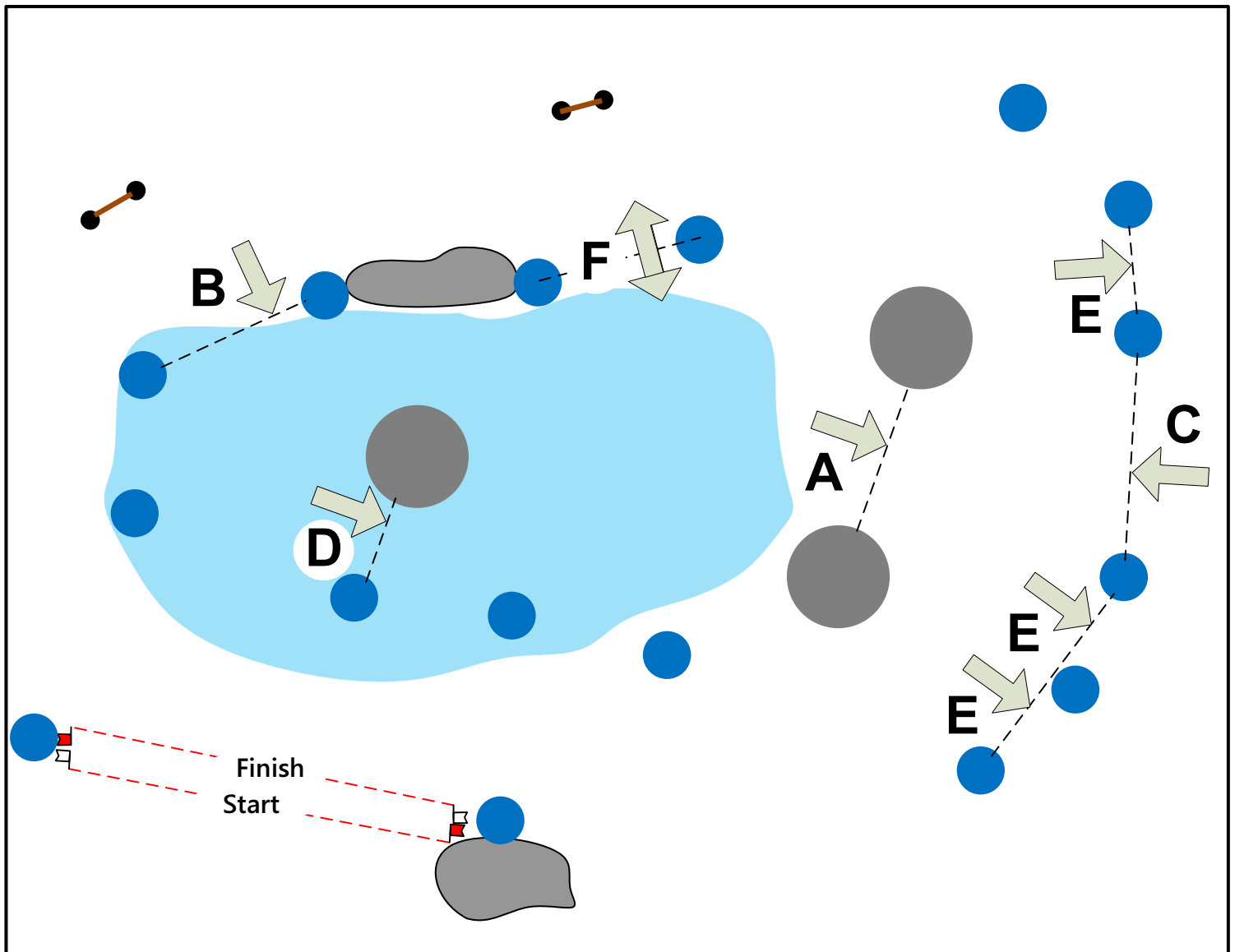



Internationales Fahrturnier
International Driving Event
CAI 3*/CAI 2*
Nationales Fahrturnier
CAN
11.04.-14.04.2024

Hindernis
Obstacle
4

Powered by:



Märchenwald

CAI 3* Gate A-F
CAI 2* only Gate A-E

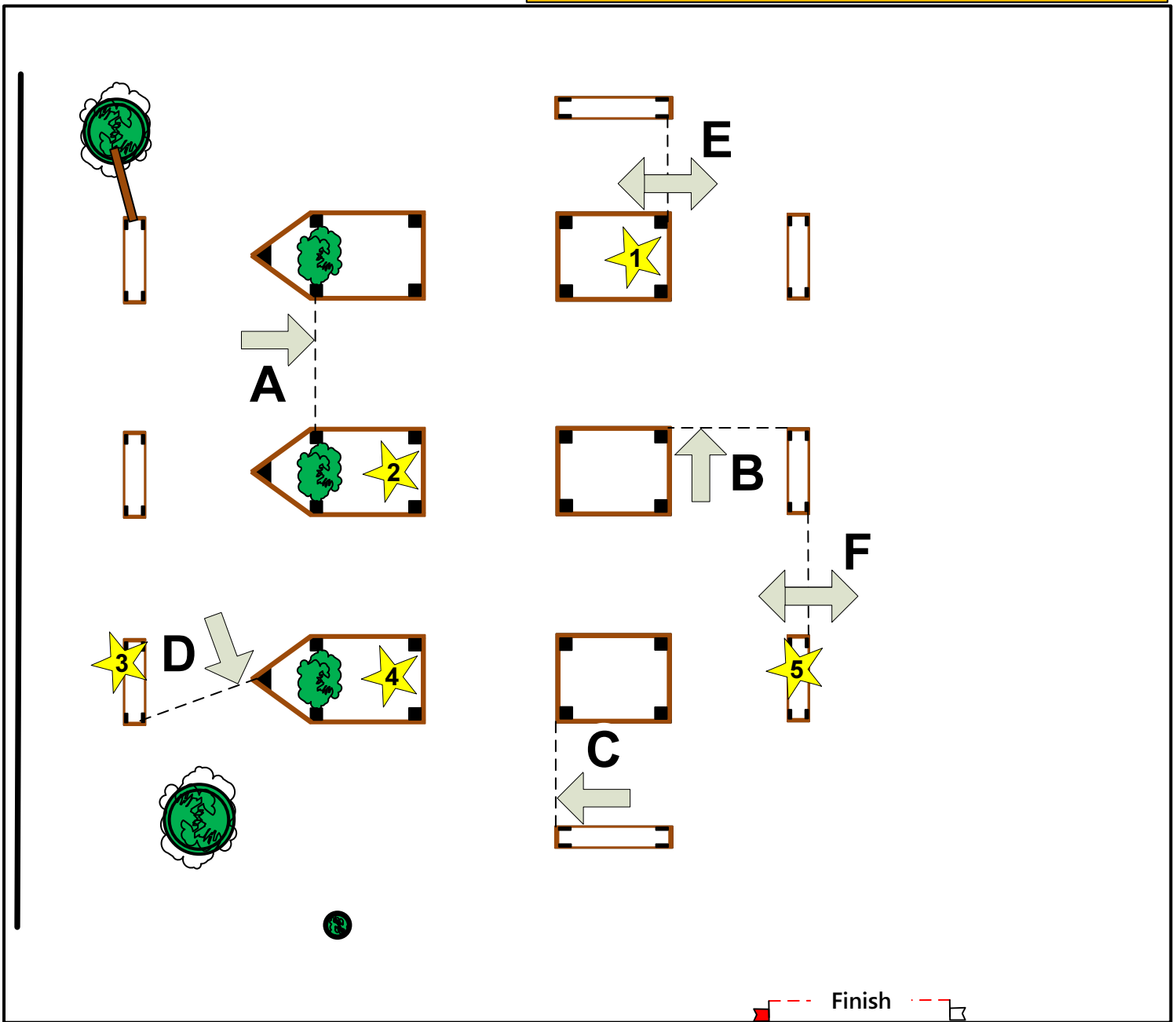

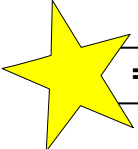
 = 5 Knock Down

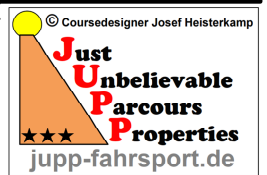



Internationales Fahrturnier
International Driving Event
CAI 3*/CAI 2*
Nationales Fahrturnier
CAN
11.04.-14.04.2024

Hindernis
Obstacle **5**

Powered by:



Elektro Brinner Brücke

Geländefahren Kl. A

Prfg.Nr: 19;23;27 und 31 nur

Tore A-D

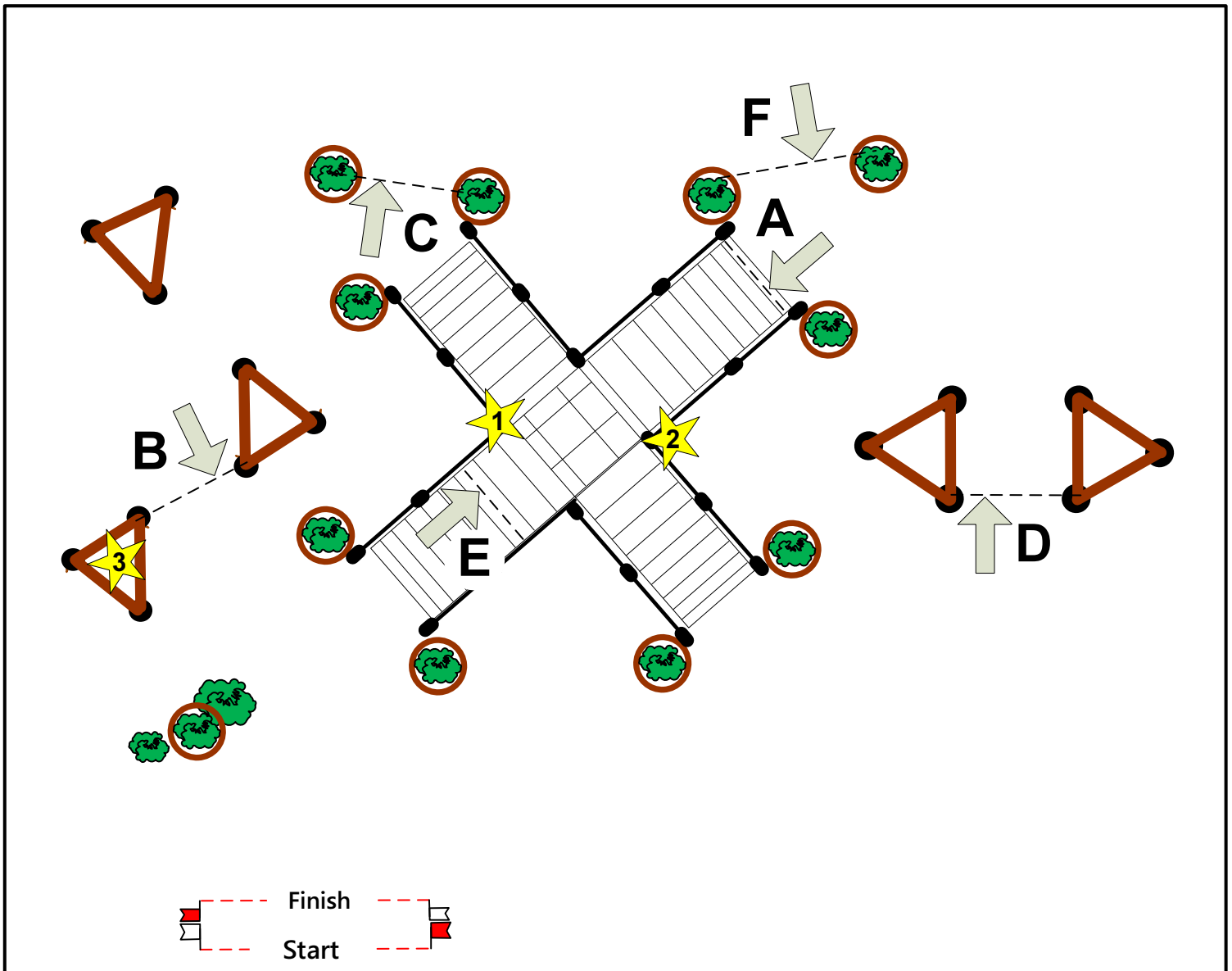

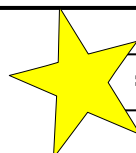
 = 3 Knock Down



Internationales Fahrturnier
International Driving Event
CAI 3*/CAI 2*
Nationales Fahrturnier
CAN
11.04.-14.04.2024

Hindernis
Obstacle **6**

Powered by:



Hüsches
PS Schuppen

Geländefahren Kl. A
Prfg.Nr: 19;23;27 und 31 nur
Tore A-D

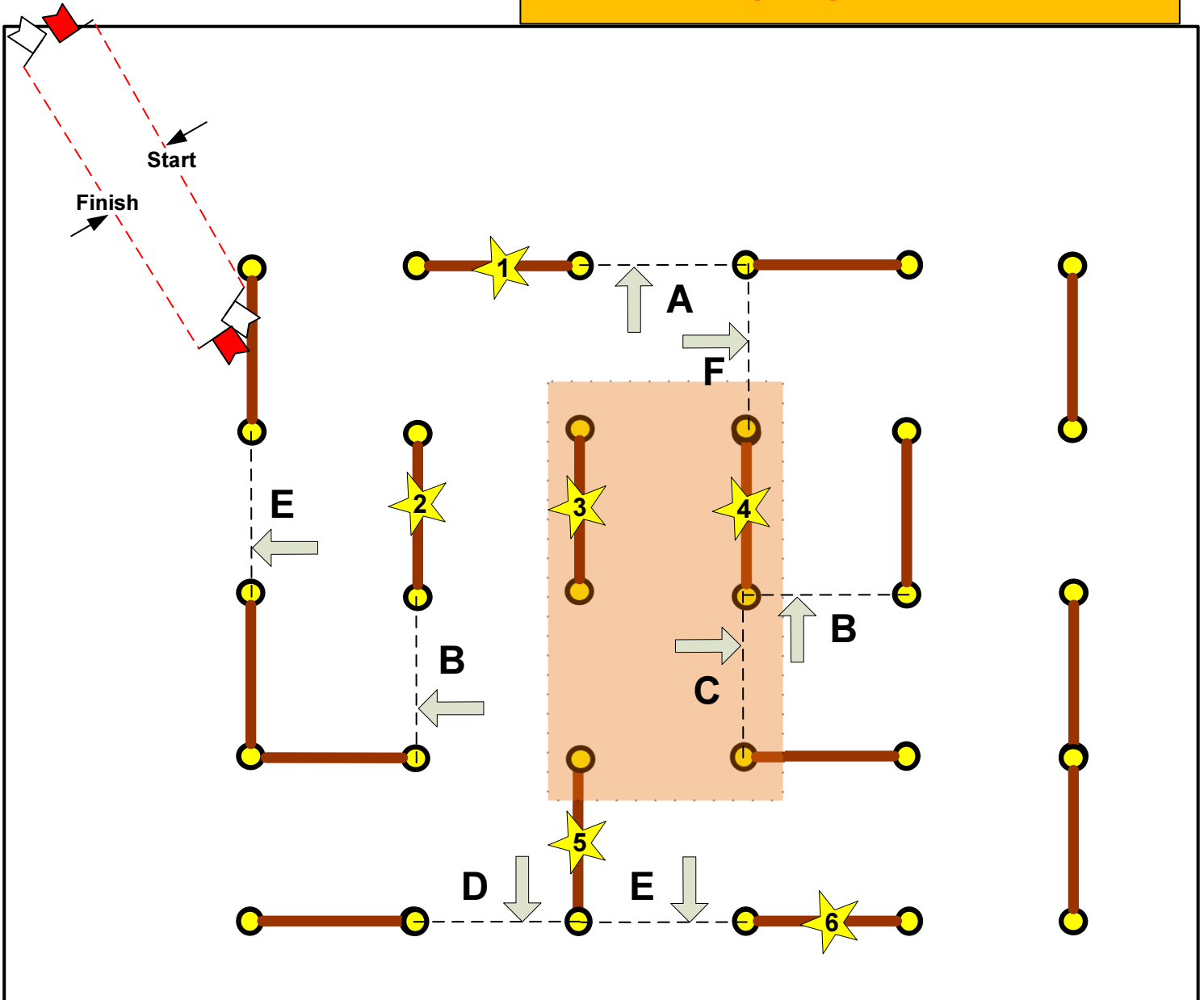

 = 6 Knock Down



**Internationales Fahrturnier
International Driving Event
CAI 3*/CAI 2*
Nationales Fahrturnier
CAN**

11.04.-14.04.2024

**Liebe Teilnehmer/innen,
Herzlich Willkommen zum diesjährigen Fahrturnier
beim
„Fahr - und Reitverein Wettringen“.
Getreu unserem Motto
„Turnier von Fahrern für Fahrer“
wünschen wir Euch viel Erfolg und vor Allem viel
Spaß!**

Teilnehmerunterlagen

CAN KI. A





**Internationales Fahrturnier
International Driving Event CAI 3*/CAI 2*
Nationales Fahrturnier CAN**

11.04.-14.04.2024

**Section A for all
classes**

**Aufwärmstrecke für
alle Klassen**

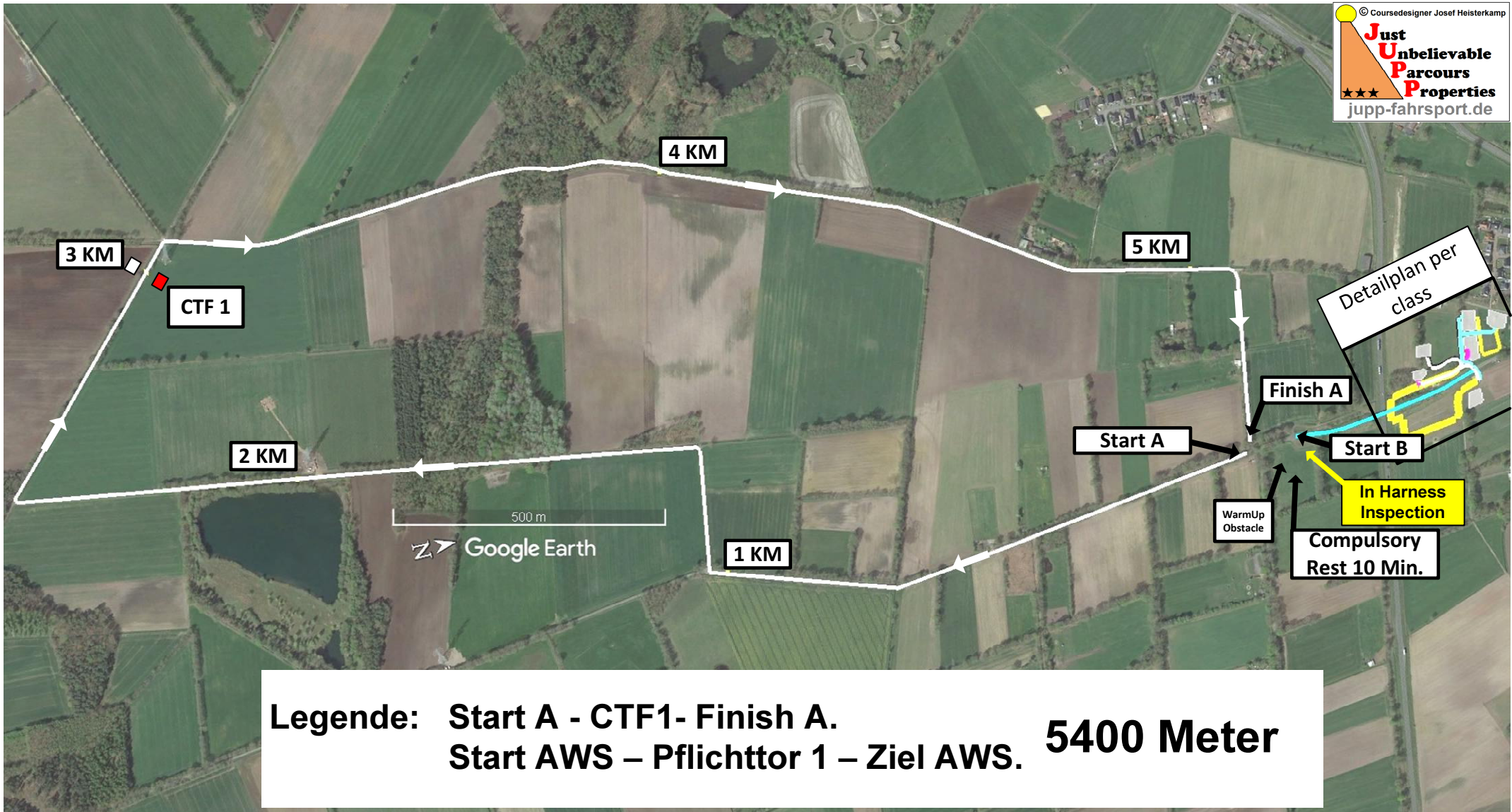



Internationales Fahrturnier International Driving Event CAI 3*/CAI 2* Nationales Fahrturnier CAN

11.04.-14.04.2024

HS KI. A

(Hindernisstrecke)
3845 Meter

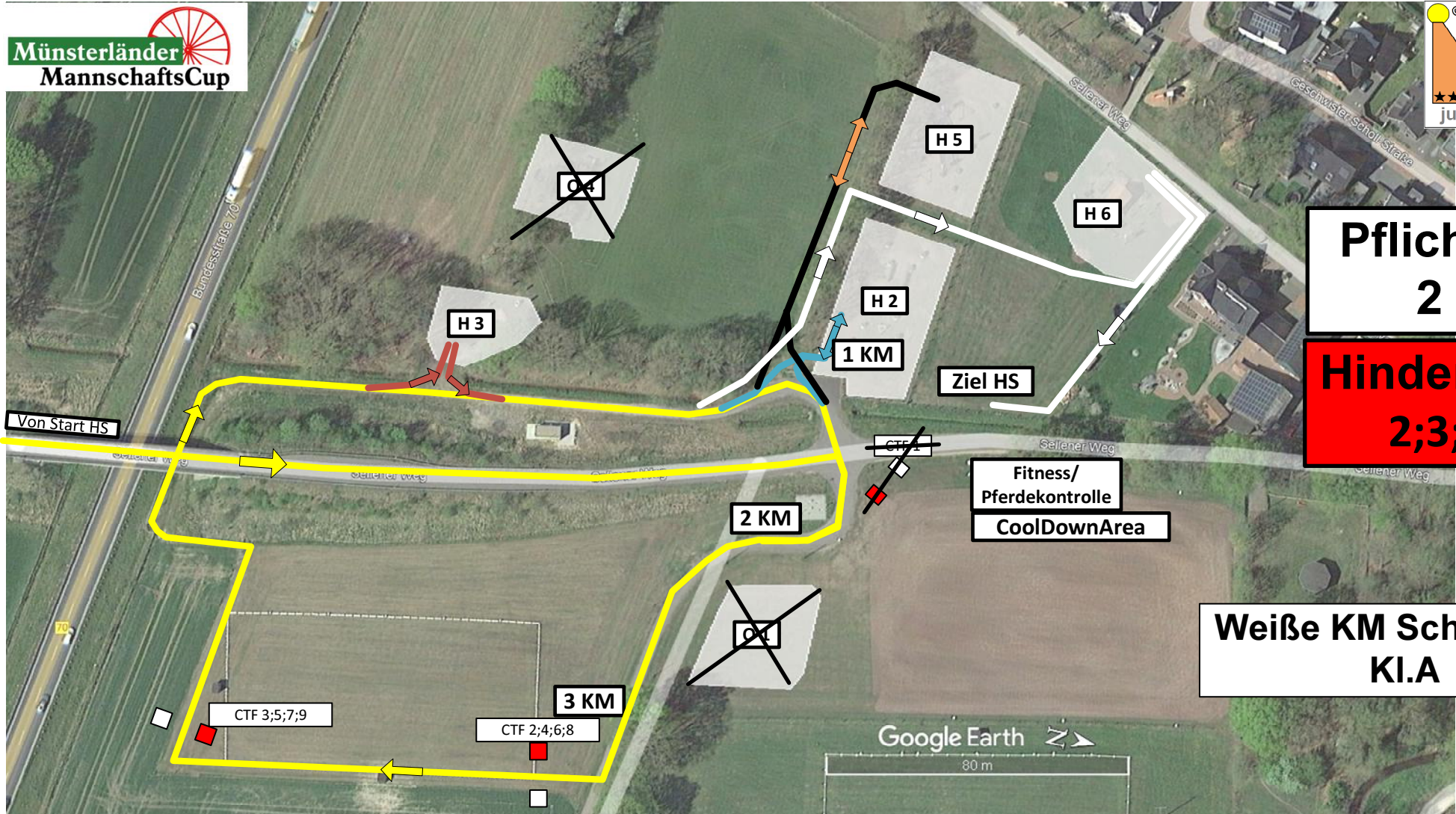
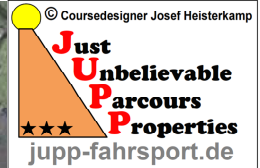

Pflichttore
2 - 9

Hindernisse
2;3;5;6

Weißer KM Schilder für
KI.A

Legende: Start HS / CTF2 / CTF3 / (H2) / 1 KM / CTF4 / CTF5 / (H3) / 2 KM / CTF6 / CTF7 / (H5) / 3 KM / CTF8 / CTF9 / (H6) / Ziel HS. 3845 Meter



Times Marathon Geländezeiten

CAI 3* H1/H2 HORSES Comp. Nr.: 10;14	Length in Meter	Tempo KM/h	Minimum Time h:min:sec	Time allowed h:min:sec	Maximum Time h:min:sec	Compulsory Turning Flags	Obstacles
Section A	5400	13	00:22:55	00:24:55	00:29:54	CTF 1	
REST				00:10:00			
Section B	5290	14	00:19:40	00:22:40	00:45:21	CTF 1-11	1 to 6
Cool Down	Area		00:10:00		00:15:00		

CAI 2* H1 HORSES Comp. Nr.: 6	Länge in Meter	Tempo KM/h	Minimum Time h:min:sec	Time allowed h:min:sec	Maximum Time h:min:sec	Compulsory Turning Flags/ Pflichttore	Obstacles
Section A	5400	12	00:25:00	00:27:00	00:32:24	CTF 1	
REST				00:10:00			
Section B	5000	13	00:20:05	00:23:05	00:46:09	CTF 2-11	2 to 6
Cool Down	Area		00:10:00		00:15:00		

CAI 2* P1 PONYS Comp. Nr.: 2	Länge in Meter	Tempo KM/h	Minimum Time h:min:sec	Time allowed h:min:sec	Maximum Time h:min:sec	Compulsory Turning Flags/ Pflichttore	Obstacles
Section A	5400	11	00:27:27	00:29:27	00:35:21	CTF 1	
REST				00:10:00			
Section B	5000	12	00:22:00	00:25:00	00:50:00	CTF 2-11	2 to 6
Cool Down	Area		00:10:00		00:15:00		

Klasse A national PFERDE Prg. Nr.: 23;31	Länge in Meter	Tempo KM/h	Minimum Time h:min:sec	Time allowed h:min:sec	Maximum Time h:min:sec	Compulsory Turning Flags/ Pflichttore	Obstacles/ Hindernisse
Aufwärmstrecke	5400	11,5	00:26:10	00:28:10	00:33:49	CTF 1	
Zwangspause				00:10:00			
Hindernisstrecke	3845	12,5	00:15:27	00:18:27	00:36:55	CTF 2-9	2;3;5;6

Klasse A national PONYS Prg. Nr.: 19;27	Länge in Meter	Tempo KM/h	Minimum Time h:min:sec	Time allowed h:min:sec	Maximum Time h:min:sec	Compulsory Turning Flags/ Pflichttore	Obstacles/ Hindernisse
Aufwärmstrecke	5400	11	00:27:27	00:29:27	00:35:21	CTF 1	
Zwangspause				00:10:00			
Hindernisstrecke	3845	12	00:16:14	00:19:14	00:38:27	CTF 2-9	2;3;5;6



Internationales Fahrturnier
International Driving Event
CAI 3*/CAI 2*
Nationales Fahrturnier
CAN
11.04.-14.04.2024

Hindernis
Obstacle **2**

Powered by:



Geländefahren Kl. A
Prfg.Nr: 19;23;27 und 31 nur
Tore A-D

Wall

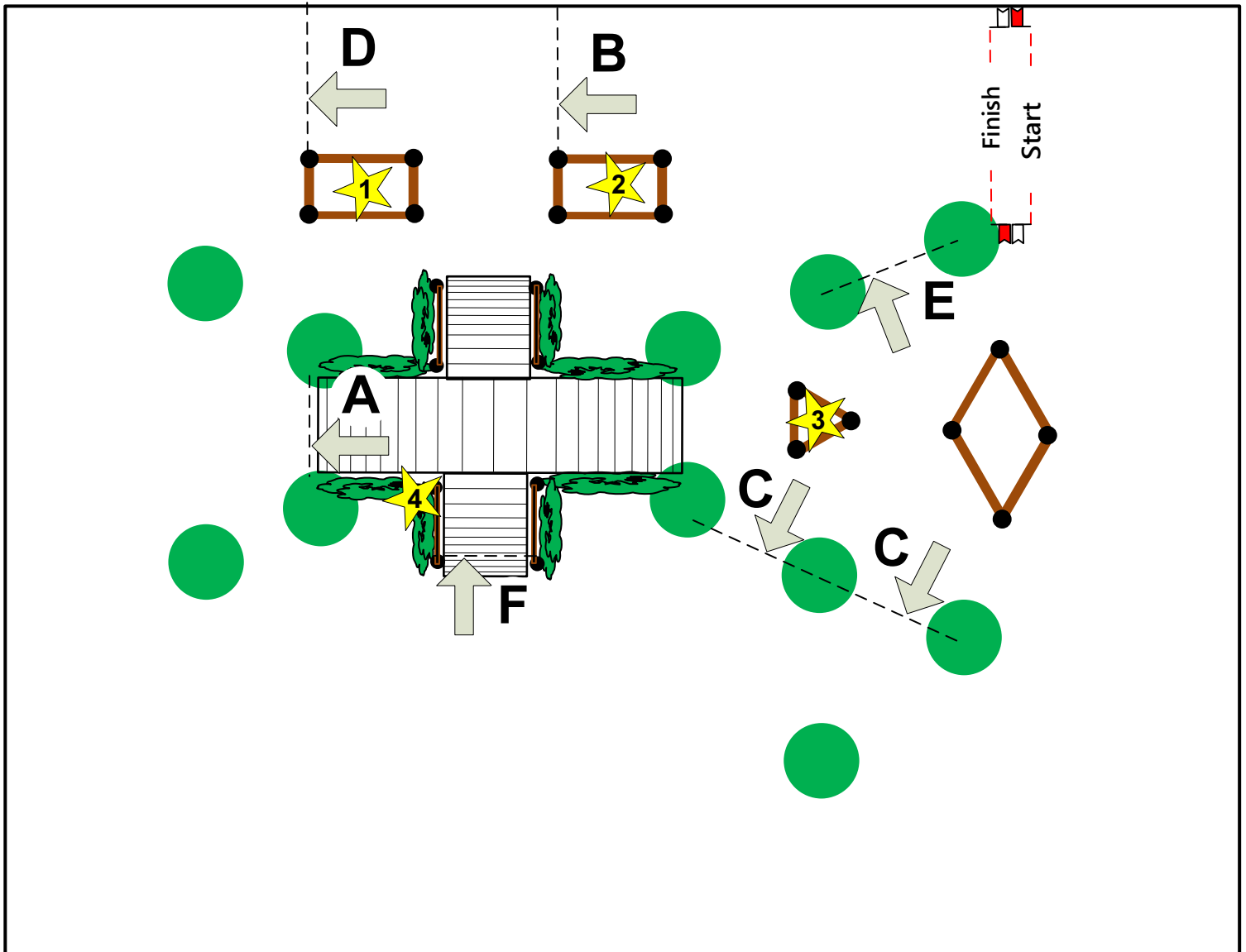

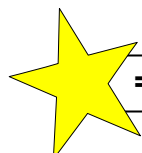
 = 4 Knock Down



Internationales Fahrturnier
International Driving Event
CAI 3*/CAI 2*
Nationales Fahrturnier
CAN
11.04.-14.04.2024

Hindernis
Obstacle **3**

Powered by:



Menzel's
Wassergraben

Geländefahren Kl. A

Prfg.Nr: 19;23;27 und 31 nur

Tore A-D

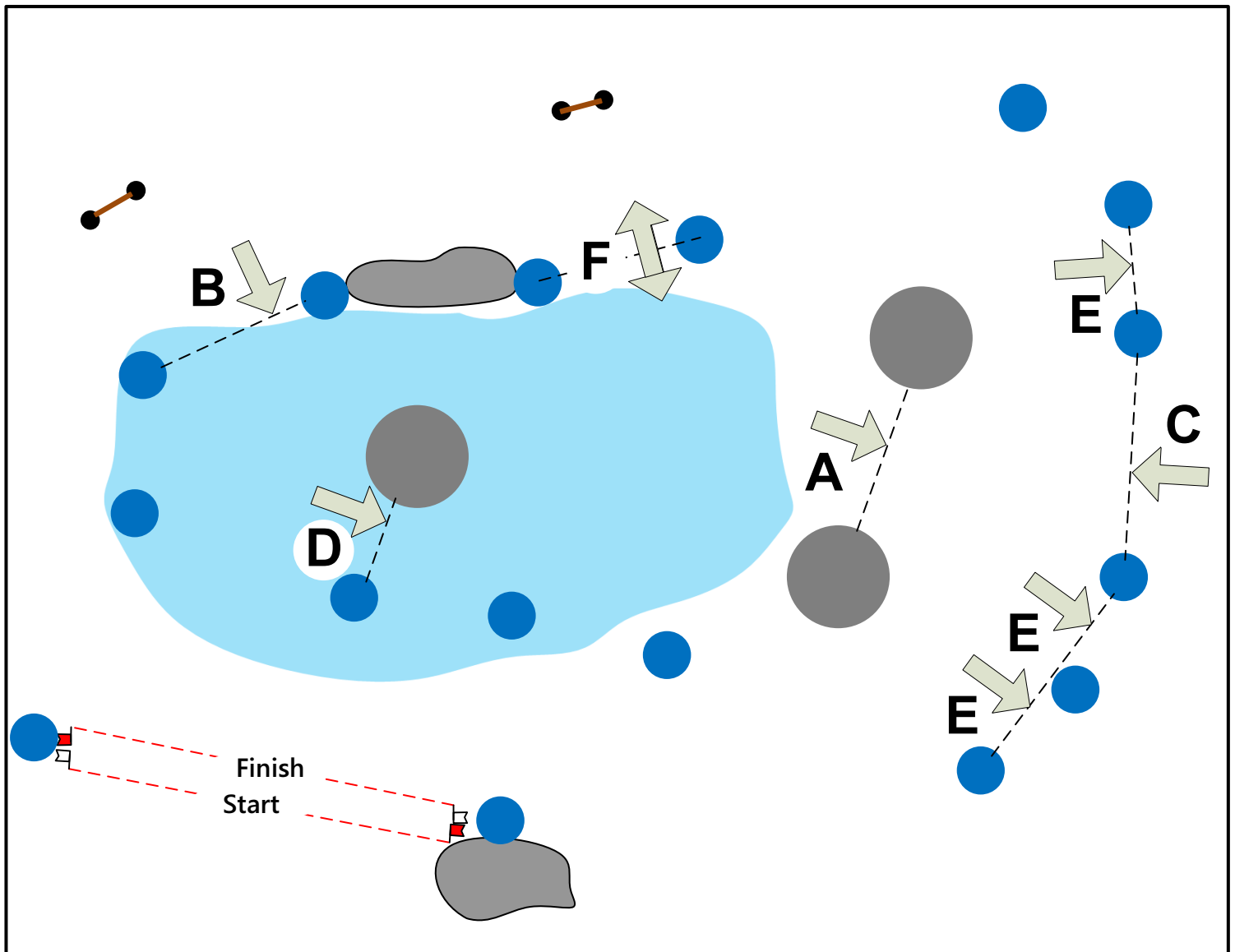



Internationales Fahrturnier
International Driving Event
CAI 3*/CAI 2*
Nationales Fahrturnier
CAN
11.04.-14.04.2024

Hindernis
Obstacle **5**

Powered by:



Elektro Brinner Brücke

Geländefahren Kl. A

Prfg.Nr: 19;23;27 und 31 nur

Tore A-D

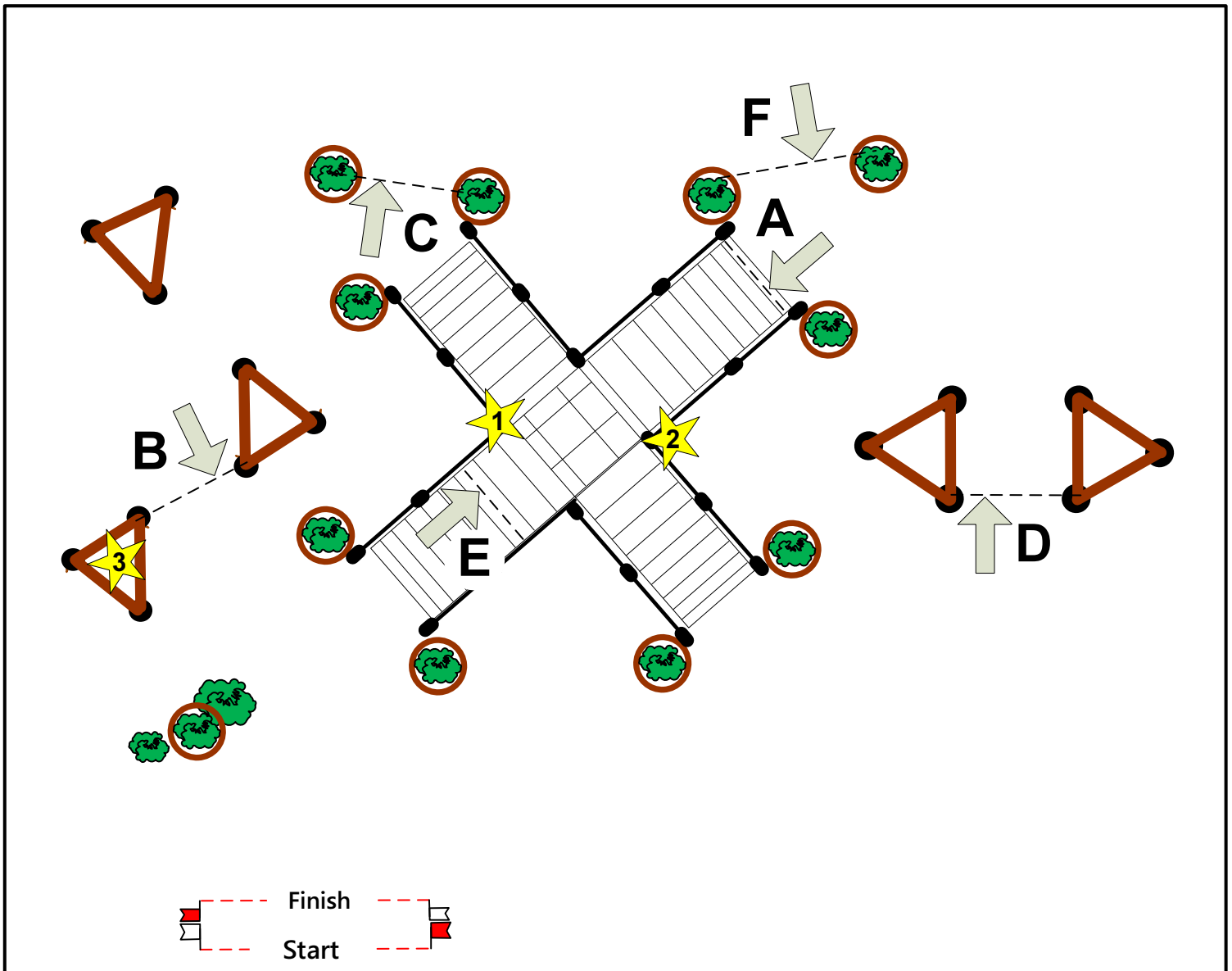

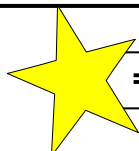
 = 3 Knock Down



Internationales Fahrturnier
International Driving Event
CAI 3*/CAI 2*
Nationales Fahrturnier
CAN
11.04.-14.04.2024

Hindernis
Obstacle **6**

Powered by:



Hüsches
PS Schuppen

Geländefahren Kl. A
Prfg.Nr: 19;23;27 und 31 nur
Tore A-D

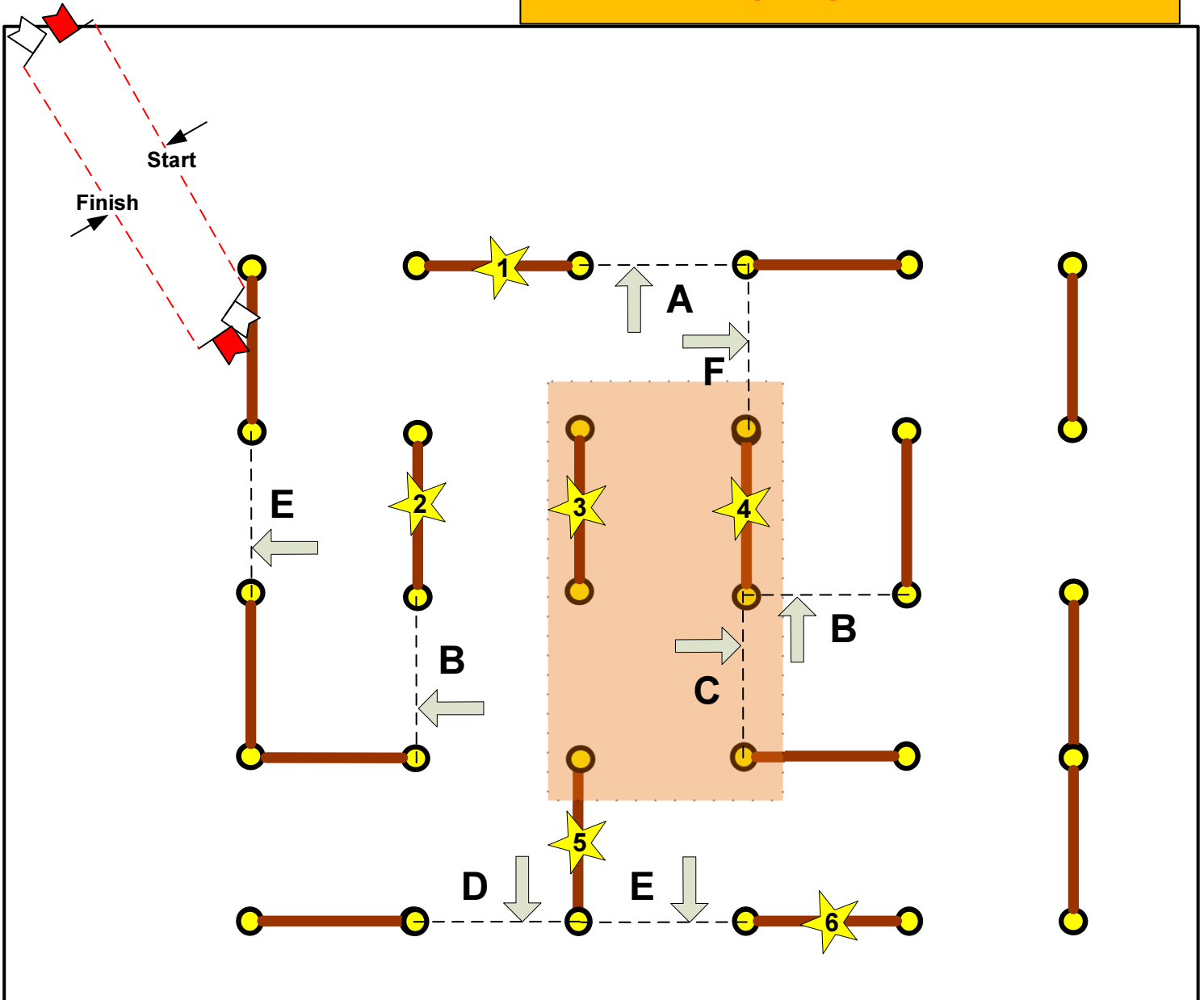

★ = 6 Knock Down



Fahr-und Reitverein Wettringen e.V.

Internationales Fahrturnier
International Driving Event
CAI 3*/CAI 2*
Nationales Fahrturnier CAN
11.04.-14.04.2024

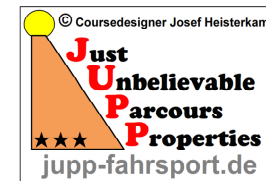

SCALE: 1:400

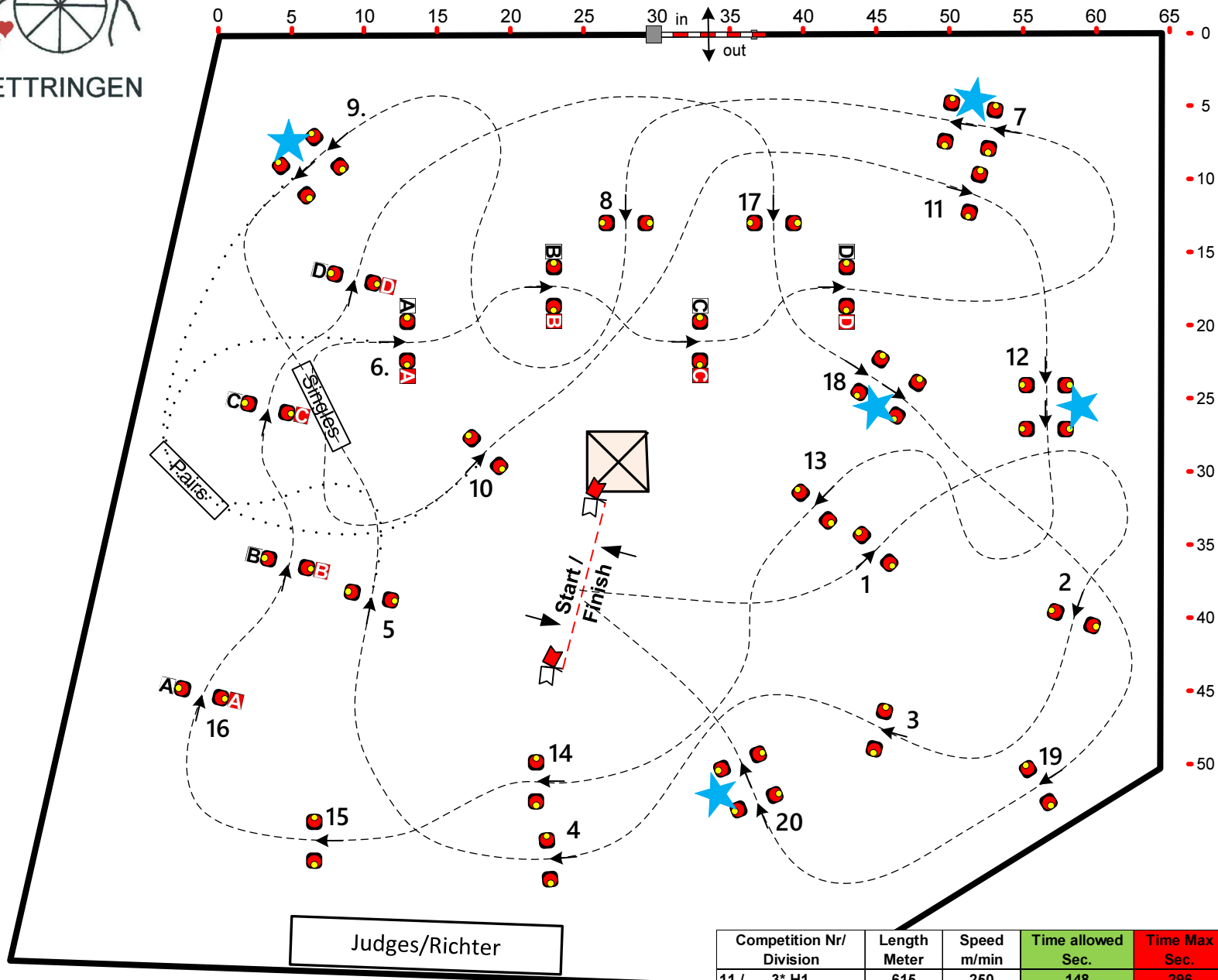

**Cones
Competition**

**Horse Single
Horse Pairs**

3*

FEI Art. 970 - 981

Competition Nr/ Division	Length Meter	Speed m/min	Time allowed Sec.	Time Max Sec.	Width cm	Width cm	Obstacles
11 / 3* H1	615	250	148	296	160	-5	20
15 / 3* H2	660	250	159	318	170		





Fahr-und Reitverein Wettringen e.V.

Internationales Fahrturnier
International Driving Event
CAI 3*/CAI 2*
Nationales Fahrturnier CAN
11.04.-14.04.2024

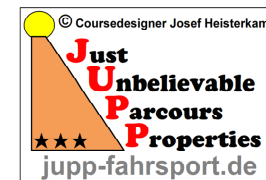

SCALE: 1:400

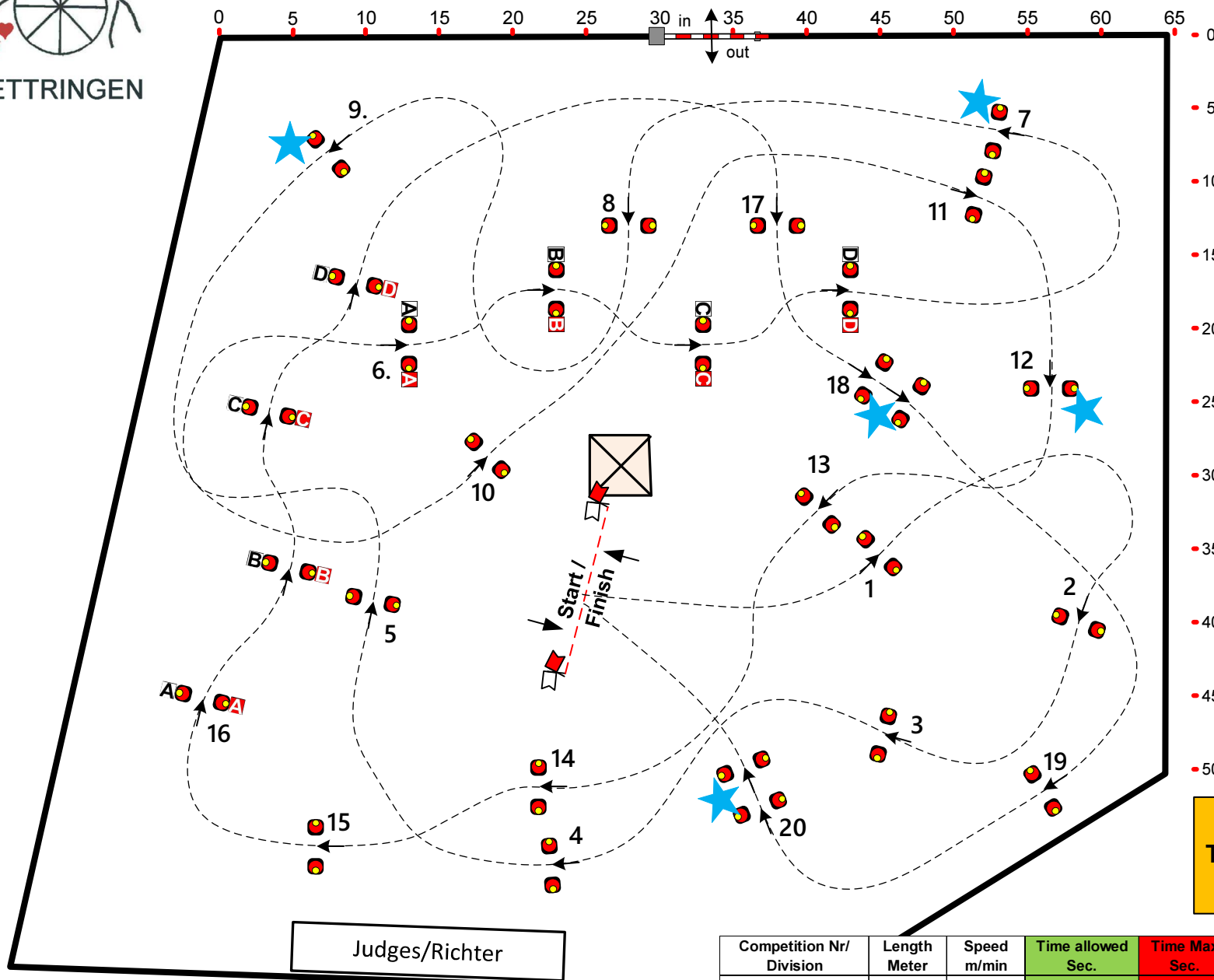

**Cones
Competition**

**Horse Single
Pony Single**

2*

FEI Art. 970 - 981

**Note for course walk:
The yellow cones are removed
for the 2-star competitions**

Judges/Richter

Competition Nr/ Division	Length Meter	Speed m/min	Time allowed Sec.	Time Max Sec.	Width cm	Width cm	Obstacles
03 / 2* P1	650	260	150	300	160	-5	20
07 / 2* H1	670	250	161	322	160	-5	20



Fahr-und Reitverein Wettringen e.V.



Internationales Fahrturnier
International Driving Event
CAI 3*/CAI 2*
Nationales Fahrturnier CAN
11.04.-14.04.2024

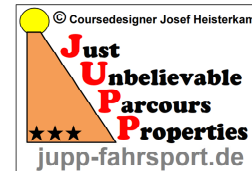

**Kegelfahren
Klasse A
Prfg.:18
Pferde
Einspanner
Prfg.:22
Ponys
Einspanner
Prfg.:26
Ponys
Zweispänner**

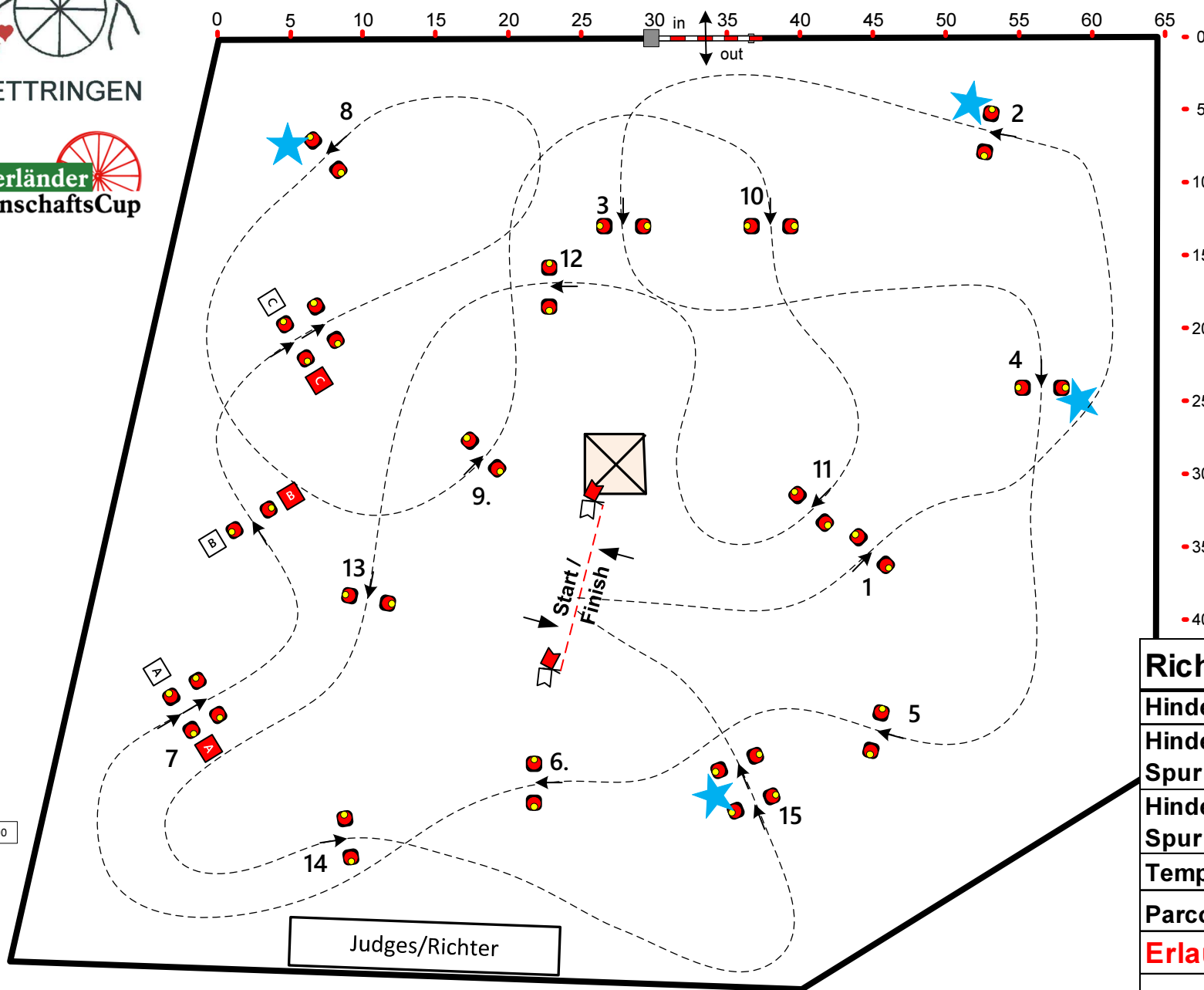

Richtverfahren 721 A	
Hindernisse Anzahl	15
Hindernisbreite= Spur zuzüglich	25 cm
Hindernisbreite=  Spur zuzüglich	20 cm
Tempo in m/min	230
Parcourslänge in m	550
Erlaubte Zeit in sec	144
Höchstzeit in sec	288



Fahr-und Reitverein Wettringen e.V.



Internationales Fahrturnier
International Driving Event
CAI 3*/CAI 2*
Nationales Fahrturnier CAN
11.04.-14.04.2024

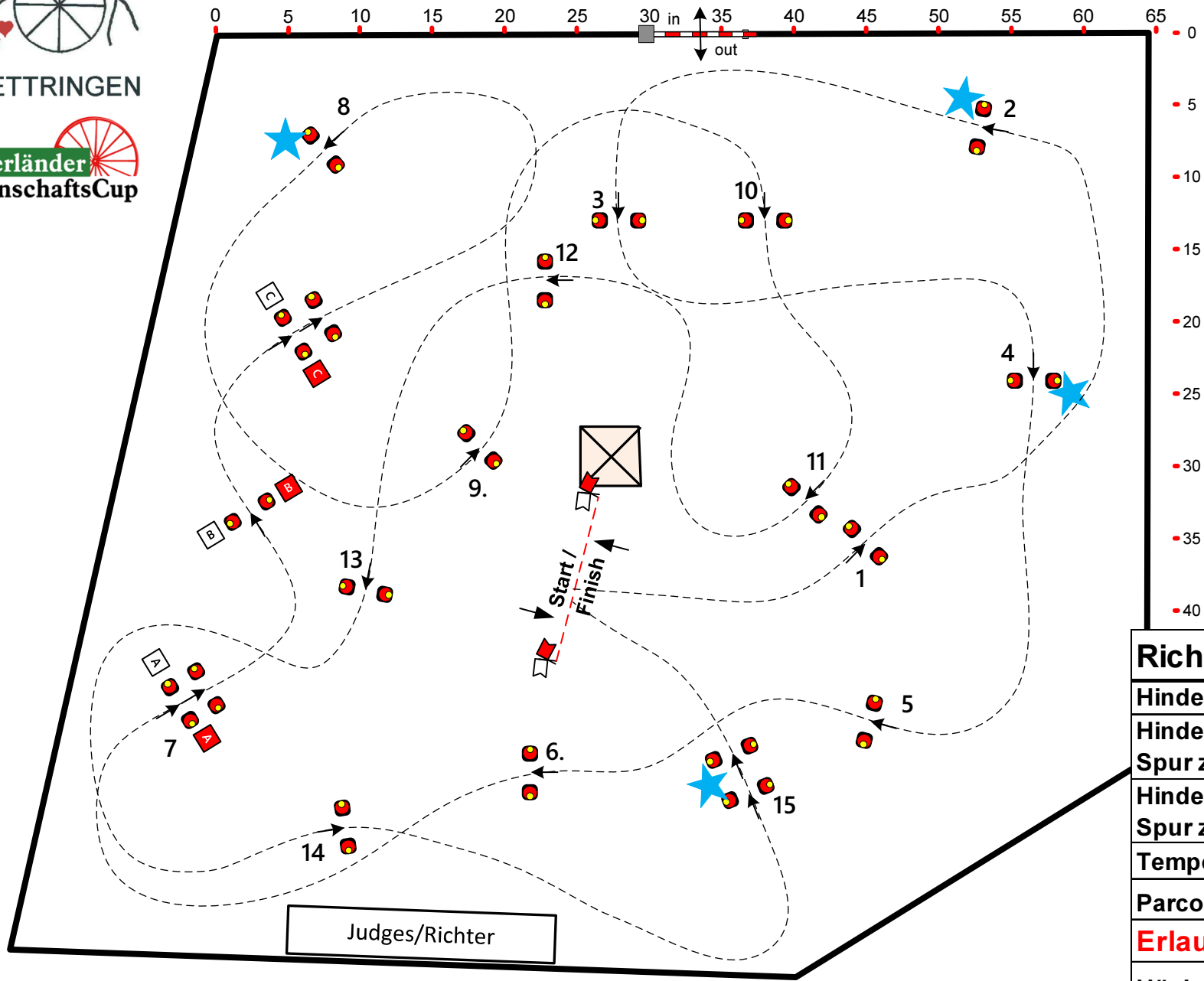
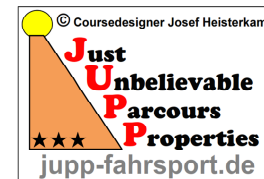

SCALE: 1:400

**Kegelfahren
Klasse A**

**Prfg.:30
Pferde
Zweispänner**

Richtverfahren 721 A	
Hindernisse Anzahl	15
Hindernisbreite= Spur zuzüglich	30 cm
Hindernisbreite= Spur zuzüglich	25 cm
Tempo in m/min	230
Parcourslänge in m	580
Erlaubte Zeit in sec	152
Höchstzeit in sec	304